

# INSTRUCTION MANUAL

## Detcon Model DM-700

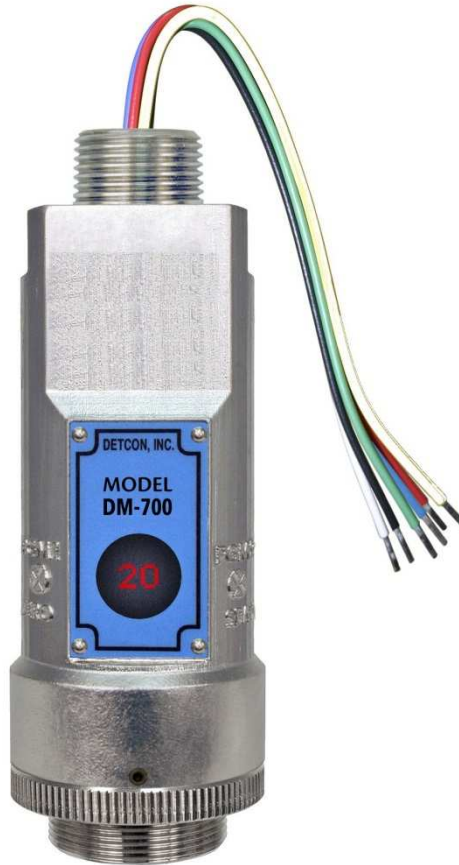

### DM-700 Toxic Gas Sensors

### DM-700 O<sub>2</sub> Deficiency Sensors

This manual covers all ranges of electrochemical and O<sub>2</sub> deficiency sensors offered in the Detcon Product Line



◆ DETCON, Inc.  
4055 Technology Forest Blvd.,  
The Woodlands, Texas 77381  
Ph.281.367.4100 / Fax 281.298.2868  
[www.detcon.com](http://www.detcon.com)

Page intentionally blank

# Table of Contents

1.	Introduction .....	1
1.1	Description .....	1
1.2	Sensor Electronics Design .....	2
1.3	Modular Mechanical Design .....	3
1.4	Intelligent Plug-in Electrochemical Gas Sensor .....	4
2.	Installation .....	5
2.1	ATEX Operational Guidelines for Safe Use .....	5
2.2	Sensor Placement .....	6
2.3	Sensor Contaminants and Interference .....	7
2.4	Mounting Installation .....	7
2.5	Electrical Installation .....	8
2.6	Field Wiring .....	9
2.7	Initial Start Up .....	11
2.7.1	Toxic Gas Sensors .....	11
2.7.2	O <sub>2</sub> Deficiency Sensors .....	12
3.	Operation .....	13
3.1	Programming Magnet Operating Instructions .....	13
3.2	Operator Interface .....	14
3.3	Normal Operation .....	15
3.4	Calibration Mode .....	16
3.4.1	AutoZero .....	16
3.4.2	AutoSpan .....	16
3.5	Program Mode .....	19
3.5.1	View Sensor Status .....	19
3.5.2	Set AutoSpan Level .....	21
3.5.3	Set Serial ID .....	21
3.5.4	Set Range .....	21
3.5.5	Signal Output Check .....	22
3.5.6	Restore Factory Defaults .....	22
3.6	Program Features .....	23
3.6.1	Operational Features .....	23
3.6.2	Fault Diagnostic/Failsafe Features .....	24
4.	RS-485 Modbus™ Protocol .....	27
	Content Description .....	27
5.	Service and Maintenance .....	29
5.1	Calibration Frequency .....	29
5.2	Visual Inspection .....	29
5.3	Condensation Prevention Packet .....	29
5.4	Replacement of Intelligent Plug-in Sensor .....	29
5.5	Replacement of ITM .....	30
5.6	Replacement of DM-700 Sensor Assembly .....	31
6.	Troubleshooting Guide .....	32
7.	Customer Support and Service Policy .....	35
7.1	Warranty Notice .....	35
8.	DM-700 Sensor Warranty .....	36
9.	Appendix .....	37
9.1	Specifications .....	37
9.2	Interference Table .....	40
9.3	Proper Application and Maintenance of Acrylonitrile Sensor .....	46
9.4	Spare Parts, Sensor Accessories, Calibration Equipment .....	47
9.5	Model DM-700 Engineering Drawings .....	47

10.	Revision Log .....	48
-----	--------------------	----

## Table of Figures

Figure 1	Construction of Electrochemical Toxic Sensor.....	1
Figure 2	Construction of Galvanic Cell.....	2
Figure 3	ITM Circuit Functional Block Diagram.....	2
Figure 4	Sensor Assembly Front View .....	3
Figure 5	Sensor Assembly Breakaway.....	3
Figure 6	Intelligent Plug-in Sensor.....	4
Figure 7	ATEX Approval Label.....	5
Figure 8	Outline and Mounting Dimensions .....	8
Figure 9	Typical Installation .....	9
Figure 10	Sensor Wire Connections.....	10
Figure 11	Magnetic Programming Tool .....	13
Figure 12	Magnetic Programming Switches .....	13
Figure 13	DM-700 Software Flowchart .....	15
Figure 14	Sensor Assembly.....	29
Figure 15	Sensor Cell and ITM Mating .....	30
Figure 16	Sensor Cell and ITM Mating .....	32

## List of Tables

Table 1	Wire Gauge vs. Distance .....	10
Table 2	Modbus™ Registers .....	27
Table 3	Modbus™ Special Registers .....	28
Table 4	Sensor Specific Data .....	39
Table 5	Interfering Gasses.....	40
Table 6	Cross Interference Table pg.1 .....	41

# 1. Introduction

## 1.1 Description



Detcon Model DM-700 toxic gas and O<sub>2</sub> deficiency sensors are non-intrusive “Smart” sensors designed to detect and monitor a wide range of toxic gasses in air. Ranges of detection for toxic gasses are from 0-1ppm up to 0-10,000ppm. Ranges for O<sub>2</sub> deficiency are 0-100ppm up to 0-25% by volume. The sensor features an LED display of current reading, fault and calibration status. The Sensor is equipped with standard analog 4-20mA and Modbus™ RS-485 outputs. A primary feature of the sensor is its method of automatic calibration, which guides the user through each step via fully scripted instructions displayed on the LED display.

The microprocessor-supervised electronics are packaged in an encapsulated module and housed in an explosion proof casting, called the ITM (Intelligent Transmitter Module). The ITM includes a four character alpha/numeric LED used to display sensor readings, and the sensor’s menu driven features when the hand-held programming magnet is used.

### Electrochemical Sensor Technology

The Toxic gas sensors are based on electrochemical cells. Each cell consists of three electrodes embedded in an electrolyte solution all housed beneath a diffusion membrane. Sensitivity to specific target gasses is achieved by varying composition of any combination of the sensor components. Good specificity is achieved in each sensor type. The cells are diffusion limited via small capillary barriers resulting in a long service life of up to three or more years. The electrochemical cell is packaged as a field replaceable intelligent plug-in sensor.

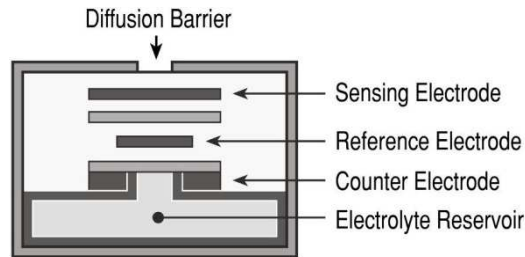

**Figure 1 Construction of Electrochemical Toxic Sensor**

The O<sub>2</sub> deficiency sensor technology is a two electrode galvanic metal air battery type cell, which is housed as a field replaceable intelligent plug-in sensor. The cell is diffusion limited and functions as a direct current generator proportional to the amount of oxygen adsorption. The sensors are temperature compensated and show good accuracy and stability over the operating temperature range of -20° to 50°C (-4° to +122° Fahrenheit). The sensor is warranted for two years and has an expected service life of up to 2.5 years in ambient air at 20.9% oxygen.

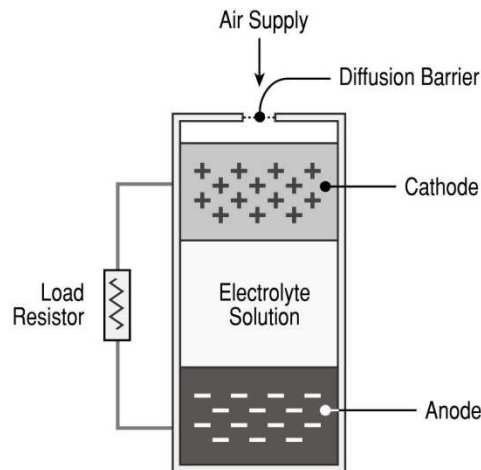

Figure 2 Construction of Galvanic Cell

## 1.2 Sensor Electronics Design

### Intelligent Transmitter Module

The DM-700 Intelligent Transmitter Module (ITM) is a fully encapsulated microprocessor-based package that is universal in design and will accept any Detcon intelligent plug-in electrochemical gas sensor. The ITM design uses an internal intrinsically safe barrier circuit that lifts the requirement for use of flame arrestors to achieve Class 1, Division 1 (Zone1) area classification. This facilitates fast response times and improved calibration repeatability on highly corrosive gas types. The ITM circuit functions include extensive I/O circuit protection, on-board power supplies, internal intrinsically safe barrier circuit, microprocessor, LED display, magnetic programming switches, a linear 4-20mA DC output, and a Modbus™ RS-485 output. Magnetic program switches located on either side of the LED Display are activated via a hand-held magnetic programming tool, thus allowing non-intrusive operator interface with the ITM. Calibration can be accomplished without declassifying the area. Electrical classifications are Class I, Division 1, Groups B C D and Class I, Zone 1, Group IIC.

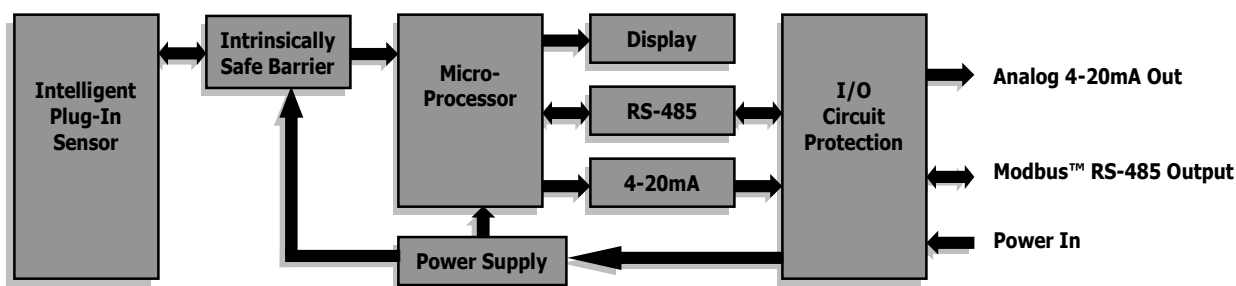

Figure 3 ITM Circuit Functional Block Diagram

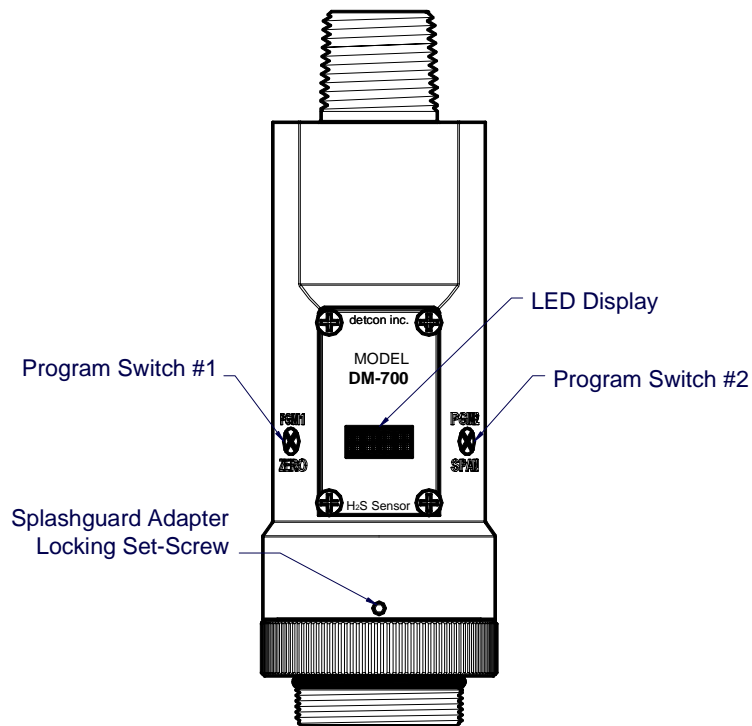

Figure 4 Sensor Assembly Front View

### 1.3 Modular Mechanical Design

The Model DM-700 Sensor Assembly is completely modular and is made up of four parts (See Figure 5 for Assembly Break-away):

- 1) DM-700 Intelligent Transmitter Module (ITM)
- 2) Intelligent Plug-in Sensor (varies by gas type and range)
- 3) Model DM-700 Splash Guard Adapter
- 4) Splash Guard.

NOTE: All metal components are constructed from electro polished 316 Stainless Steel in order to maximize corrosion resistance in harsh environments.

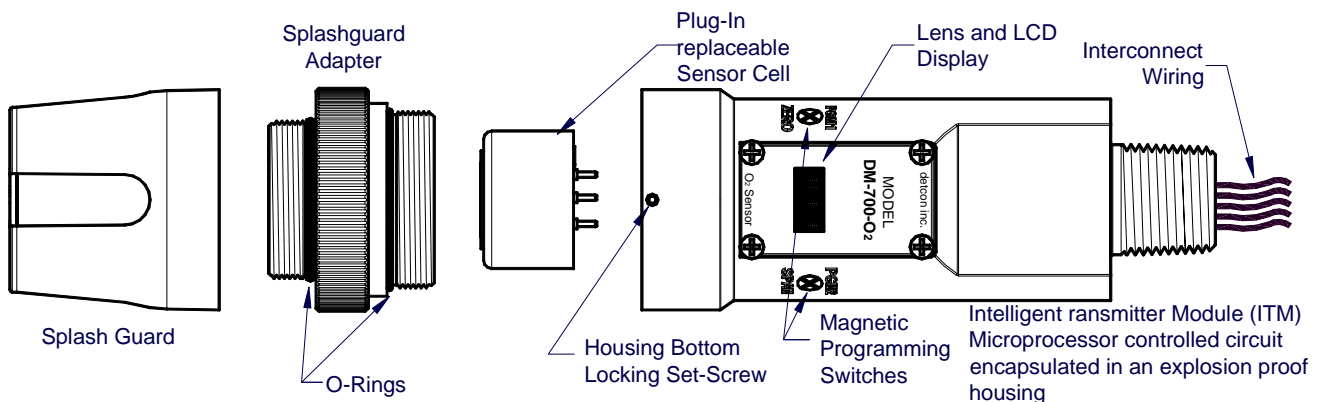
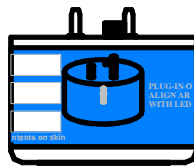

Figure 5 Sensor Assembly Breakaway

## 1.4 Intelligent Plug-in Electrochemical Gas Sensor

The Detcon family of electrochemical gas sensors are field proven, intelligent plug-in sensors with over-sized gold-plated connections that eliminate corrosion problems. The intelligent design provides automatic recognition of gas type, units, full-scale range, and calibrations data when a new sensor is plugged in. The sensor can be accessed and replaced in the field very easily by releasing the locking setscrew and unthreading the Splashguard Adapter. Detcon's family of toxic sensors have a long shelf life and are supported by an industry-leading warranty.



**Figure 6** Intelligent Plug-in Sensor



## 2. Installation

### 2.1 ATEX Operational Guidelines for Safe Use

1. Install sensor only in areas with classifications matching with those described on the ATEX approval label. Follow all warnings listed on the label.

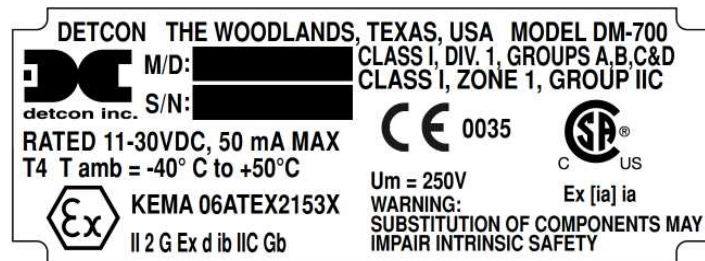

Figure 7 ATEX Approval Label

2. Ensure that the sensor is properly threaded into a suitable explosion-proof rated junction box with a downward pointing female  $\frac{3}{4}$ " NPT threaded connection. The sensor should be threaded up at least 5 full turns until tight, with the LED display facing forward. Avoid use of Teflon Tape, or any type of non-conductive pipe thread coating on the NPT threaded connection.
3. A good ground connection should be verified between the sensor's metal enclosure and the junction box. If a good ground connection is not made, the sensor can be grounded to the junction box using the sensor's external ground lug. Also verify a good ground connection between the junction box and earth ground.
4. Ensure that the Housing Bottom and plug-in sensor are installed during operation. The Housing Bottom should be threaded tightly to the Intelligent Transmitter Module. The locking setscrew (M3.5 x 0.6 6g6h Stainless Steel Allen set screw cup point with yield strength of greater than 40,000 PSI, typical 80,000 PSI) should then be tightened down to keep the Housing Bottom from being inadvertently removed or from becoming loose under vibration. The locking setscrew ensures that Housing Bottom is only removable by authorized personnel with the use of special tools. A M1.5 Allen Wrench is required. If screw requires replacement, only an identical screw may be used.
5. Proper precautions should be taken during installation and maintenance to avoid the build-up of static charge on the plastic components of the sensor. These include the splashguard and splashguard adapter.
6. The screws holding down the retaining plate label are special fasteners of type Stainless Steel, Phillips Pan-head Machine screw, M3 x 0.5 6g6h having yield strength of greater than 40,000 PSI, typical 80,000 PSI. If screw requires replacement, only an identical screw may be used.
7. Do not substitute components that are not authorized by the scope of the safety approval. This may impair the intrinsic safety rating.
8. Do not operate the sensor outside of the stated operating temperature limits.
9. Do not operate the sensor outside the stated operating limits for voltage supply.

10. The sensor power supply common (black wire) must be referenced to the metal enclosure body (ground) during installation.
11. These sensors meet EN60079-0:2009, EN60079-1:2007, EN60079-11:2012 and EN 50020
12. These sensors have a maximum safe location voltage of  $U_m=250V$ .
13. These sensors pass dielectric strength of 500VRMS between circuit and enclosure for a minimum of 1 minute at a maximum test current of 5mA.

## 2.2 Sensor Placement

Selection of sensor location is critical to the overall safe performance of the product. Six factors play an important role in selection of sensor locations:

- (1) Density of the gas to be detected
- (2) Most probable leak sources within the industrial process
- (3) Ventilation or prevailing wind conditions
- (4) Personnel exposure
- (5) Maintenance access
- (6) Additional placement considerations

### Density

Placement of sensors relative to the density of the target gas is such that sensors for the detection of heavier than air gasses should be located within 4 feet of grade as these heavy gasses will tend to settle in low lying areas. For gasses lighter than air, sensor placement should be 4-8 feet above grade in open areas or in pitched areas of enclosed spaces.

### Leak Sources

The most probable leak sources within an industrial process include flanges, valves, and tubing connections of the sealed type where seals may either fail or wear. Other leak sources are best determined by facility engineers with experience in similar processes.

### Ventilation

Normal ventilation or prevailing wind conditions can dictate efficient location of gas sensors in a manner where the migration of gas clouds is quickly detected.

### Personnel Exposure

The undetected migration of gas clouds should not be allowed to approach concentrated personnel areas such as control rooms, maintenance or warehouse buildings. A more general and applicable thought toward selecting sensor location is combining leak source and perimeter protection in the best possible configuration.

### Maintenance Access

Consideration should be given to providing easy access for maintenance personnel. Consideration should also be given to the consequences of close proximity to contaminants that may foul the sensor prematurely.

---

**NOTE:** All installations of the gas sensor should point straight down (refer to Figure 9). Improper sensor orientation may result in false readings and permanent sensor damage.

---

## **Additional Placement Considerations**

The sensor should not be positioned where it may be sprayed or coated with surface contaminating substances. Painting sensor assemblies is prohibited.

Although the sensor is designed to be RFI resistant, it should not be mounted in close proximity to high-powered radio transmitters or similar RFI generating equipment.

Mount in an area void of high wind, accumulating dust, rain or splashing from hose spray, direct steam releases, and continuous vibration. If the sensor cannot be mounted away from these conditions then make sure the Detcon Harsh Environment Splashguard accessory is used.

Do not mount in locations where temperatures will exceed the operating temperature limits of the sensor. Where direct sunlight leads to exceeding the high temperature-operating limit, use a sunshade to help reduce temperature.

## **2.3 Sensor Contaminants and Interference**

Electrochemical toxic gas may be adversely affected by exposure to other airborne gasses. Depending on the cross-sensitivity relationship, there may be a positive or negative impact on the reading.

The most commonly present gasses that potentially cause interference problems are listed in Table 6 Cross Interference Table (refer to Section 9).

The presence of cross-interference gasses in an area does not preclude the use of this sensor technology, although it is possible that the sensor could experience a false high or false low reading should exposure occur.

### **Cross-Interference Data Table**

Table 6 Cross Interference Table (refer to Section 9) lists the gasses typically found in industrial environments that may cause a cross-interference response on members of the Detcon family of toxic gas sensors. Review Table 6 in Section 9 for the correct gas and then scan across the list for possible interference gasses. Determine the magnitude of cross-interference that may occur.

## **2.4 Mounting Installation**

The DM-700 sensor assembly is designed to be threaded into a ¾" Female NPT fitting of a standard cast metal, Explosion-Proof Enclosure or Junction Box. There are two wrench flats on the upper section of the sensor that should be used to thread the sensor into the ¾" female NPT receiving connection. Thread the sensor up until tight (5 turns is typically expected) and until the display is pointed in the direction that sensor will normally be viewed and accessed.

The DM-700 should be vertically oriented so that the sensor points straight down. The explosion-proof enclosure or junction box would then typically be mounted on a wall or pole. Detcon provides a standard selection of junction boxes available as sensor accessories (See Figure 8 below). Any appropriately rated enclosure with a downward facing ¾" NPT female connection will suffice.

When mounting on a wall, it is recommended to use a 0.25"-0.5" spacer underneath the mounting ears of the Detcon standard J-Box to offset the sensor assembly from the wall and create open access around the sensor assembly. Spacing requirements for other junction boxes may vary.

When mounting on a pole, secure the Junction Box to a suitable mounting plate and attach the mounting plate to the pole using U-Bolts. (Pole-Mounting brackets for Detcon J-box accessories are available separately.)

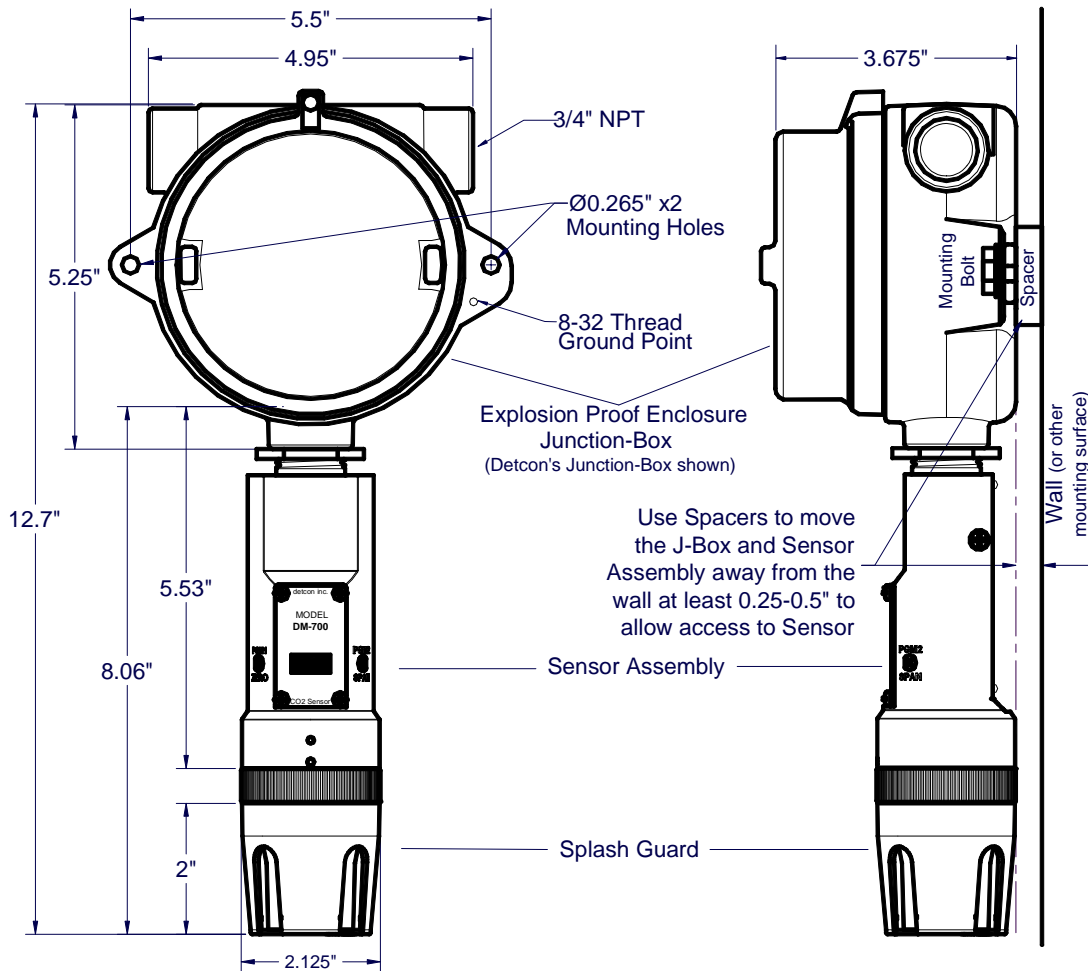

Figure 8 Outline and Mounting Dimensions

## 2.5 Electrical Installation

The Sensor Assembly should be installed in accordance with local electrical codes. The sensor assemblies are CSA/NRTL approved (US and Canada) for Class I, Division 1, Groups B, C, & D area classifications, and are ATEX Approved for Class I, Zone 1, Group IIC area classifications.

Proper electrical installation of the gas sensor is critical for conformance to Electrical Codes and to avoid damage due to water leakage. Refer to Figure 9 and Figure 10 for proper electrical installation.

**NOTE:** If a conduit run exits the secondary port, repeat the installation technique shown in Figure 9.

In Figure 9, the drain allows water condensation inside the conduit run to safely drain away from the sensor assembly. The electrical seal fitting is required to meet the National Electrical Code per NEC Article 500-3d (or Canadian Electrical Code Handbook Part 1 Section 18-154). Requirements for locations of electrical seals are covered under NEC Article 501-5. Electrical seals also act as a secondary seal to prevent water from entering the wiring terminal enclosure. However, they are not designed to provide an absolute water-tight seal, especially when used in the vertical orientation.

**NOTE:** A conduit seal is typically required to be located within 18" of the J-Box and Sensor Assembly. Crouse Hinds type EYS2, EYD2 or equivalent are suitable for this purpose.

**NOTE:** The Detcon Warranty does not cover water damage resulting from water leaking into the enclosure. Since the electronics are 100% epoxy encapsulated, only the wire terminations can get wet. This could cause abnormal operation and possibly cause corrosion to the terminal connections. However, it would not be expected to cause permanent damage to the sensor.

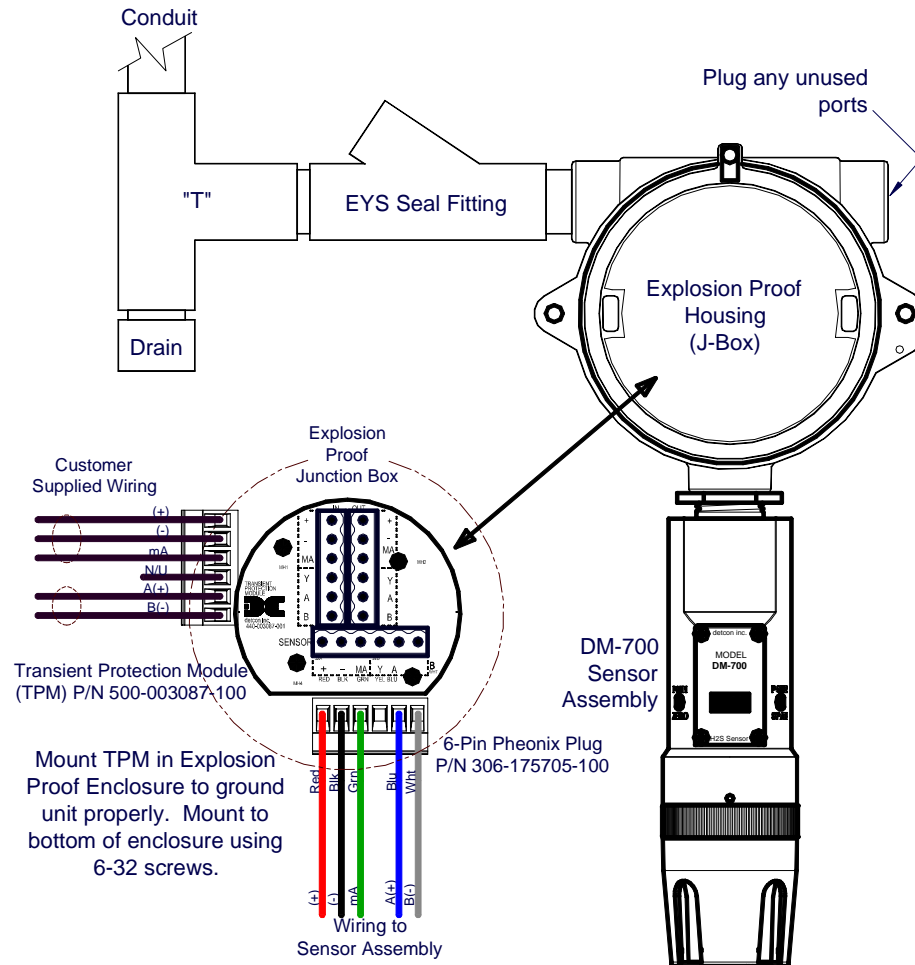

**Figure 9** Typical Installation

**NOTE:** Any unused ports should be blocked with suitable  $\frac{3}{4}$ " male NPT plugs. Detcon supplies one  $\frac{3}{4}$ " NPT male plug with their accessory J-box enclosures. If connections are other than  $\frac{3}{4}$ " NPT, use an appropriate male plug of like construction material.

## 2.6 Field Wiring

Detcon Model DM-700 toxic gas sensors assemblies require three conductor connections between power supplies and host electronic controller's 4-20mA output, and two conductor connections for the Modbus™ RS-485 serial interface. Wiring designations are + (DC), - (DC), mA (sensor signal), and Modbus™ RS-485 A (+), and B (-). Maximum wire length between sensor and 24VDC source is shown in the Table 1 below. Maximum wire size for termination in the Detcon J-Box accessory is 14 gauge.

**Table 1** Wire Gauge vs. Distance

AWG	Wire Dia.	Meters	Feet	Over-Current Protection
22	0.723mm	700	2080	3A
20	0.812mm	1120	3350	5A
18	1.024mm	1750	5250	7A
16	1.291mm	2800	8400	10A
14	1.628mm	4480	13,440	20A

**NOTE 1:** Wiring table is based on stranded tinned copper wire and is designed to serve as a reference only.

**NOTE 2:** Shielded cable is required for installations where cable trays or conduit runs include high voltage lines or other possible sources of induced interference. Separate conduit runs are highly recommended in these cases.

**NOTE 3:** The supply of power should be from an isolated source with over-current protection as stipulated in table.

**Terminal Connections**



**CAUTION:** Do not apply System power to the sensor until all wiring is properly terminated. Refer to Section 2.7 Initial Start Up

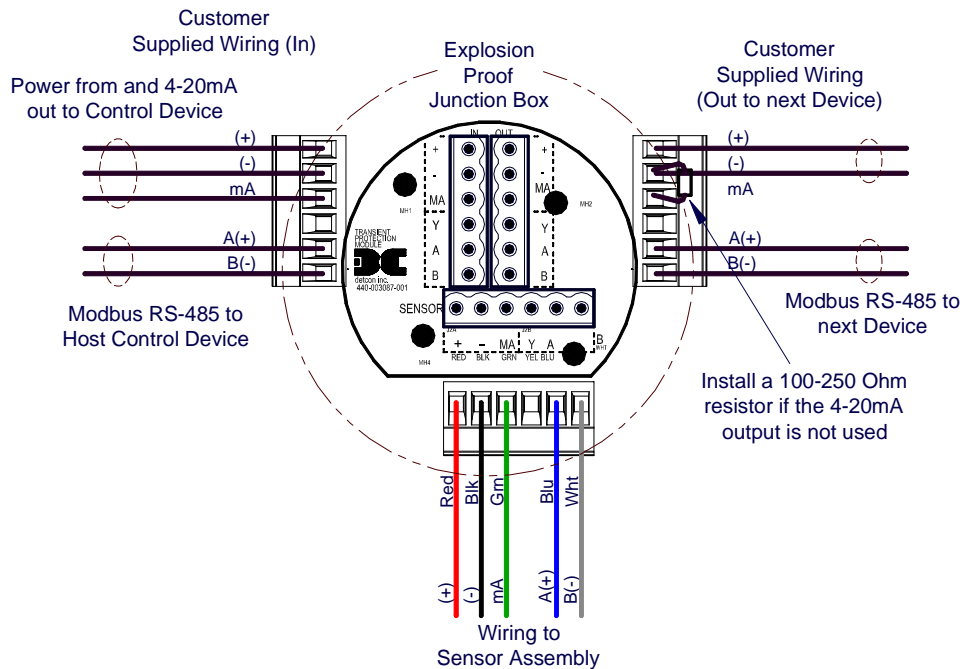

**Figure 10** Sensor Wire Connections

- a) Remove the junction box cover. Identify the terminal blocks for customer wire connections.
- b) Observing correct polarity, terminate the 3-conductor 4-20mA field wiring (+, -, mA) to the sensor assembly wiring in accordance with the detail shown in Figure 10. If the 4-20mA output is not used, install a 100-250Ω resistor between the mA and (-) terminals on the Transient Protection Module.

---

**NOTE:** If the 4-20mA output is not being used, a 100-250Ω resistor *must* be installed between the mA and (-) terminals on the Transient Protection Module to ensure RS-485 communication is not disrupted by a 4-20mA Fault.

---

- a) If applicable, terminate the RS-485 serial wiring as shown in Figure 10. Use the second plug (Out) as termination point on the customer side to facilitate a continuous RS-485 serial loop.

The RS-485 (if applicable) requires 24 gauge, two conductor, shielded, twisted pair cable between the sensor and host. General Cable Commodore part number ZO16P0022189 is recommended.

---

**NOTE:** Install a 120-ohm resistor across A & B terminals on the last sensor in the serial loop.

---

- c) Trim all exposed wire leads if they are not permanently landed in the terminal block.
- d) Replace the junction box cover.

## 2.7 Initial Start Up

Upon completion of all mechanical mounting and termination of all field wiring, apply system power in the range of 11.5-30VDC (24VDC typical) and observe the following normal conditions:

### 2.7.1 Toxic Gas Sensors

- a) DM-700 display reads “0”, and no fault messages are flashing.
- b) A temporary upscale or downscale reading may occur as the sensor stabilizes. This upscale reading will typically decrease to “0” ppm within 1-2 minutes of power-up, assuming there is no gas in the area of the sensor.
- c) Sensors that use a bias voltage require a longer time to stabilize. This can vary between 1 and 24 hours depending on the sensor type and range. Biased sensors include NH<sub>3</sub>, NO, HCl, and VOC gasses (ethylene oxide, ethylene, methanol, formaldehyde....etc.).

---

**NOTE:** The 4-20mA signal is held constant at 4mA for the first two minutes after power up.

---

### Initial Operational Tests

After a warm up period of 1 hour (or when zero has stabilized), the sensor should be checked to verify sensitivity to the target gas.

### Material Requirements

- Detcon PN 613-120000-700 700 Series Splash Guard with integral Cal Port -OR-
- Detcon PN 943-000006-132 Threaded Calibration Adapter
- Detcon Span Gas; 50% of range target gas in balance N<sub>2</sub> or Air at fixed flow rate between 200-500cc/min

---

**NOTE:** Calibration gas generators using perm tubes or electrochemical sources may be used in place of span gas cylinders.

---

- a) Attach the calibration adapter to the threaded sensor housing or connect tubing to integral cal port. Apply the test gas at a controlled flow rate of 200 - 500cc/min (500cc/min is the recommended flow). Observe that the ITM display increases to a level near that of the applied calibration gas value.
- b) Remove test gas and observe that the ITM display decreases to "0".

Initial operational tests are complete. DM-700 toxic gas sensors are factory calibrated prior to shipment, and should not require significant adjustment on start up. However, it is recommended that a complete calibration test and adjustment be performed 16 to 24 hours after power-up. Refer to zero and span calibration instructions in Section 3.4.

### 2.7.2 O<sub>2</sub> Deficiency Sensors

- a) DM-700 display reads close to 20.9% and no fault messages are flashing.
- b) The reading should stabilize within 1 to 2 minutes of power-up (assuming a 'normal' ambient O<sub>2</sub> concentration).

#### Initial Operational Tests

After a warm-up period of 5 minutes the sensor should be checked to verify response to O<sub>2</sub> deficiency.

#### Material Requirements

- Detcon PN 613-120000-700 700 Series Splash Guard with integral Cal Port -OR-
  - Detcon PN 943-000006-132 Threaded Calibration Adapter
  - Detcon Zero Gas: 100% N<sub>2</sub> at fixed flow rate of 200-500cc/min
- a) Attach the calibration adapter to the threaded sensor housing or connect tubing to the integral cal port. Apply the test gas at a controlled flow rate of 200-500cc/min (500cc/min is the recommended flow). Observe that the ITM display decreases to a level near zero.
  - b) Remove test gas and calibration adapter. The ITM display should return to a reading of 20.9%.

Initial operational tests are complete. DM-700 O<sub>2</sub> deficiency sensors are factory calibrated prior to shipment, and should not require significant adjustment on start up. However, it is recommended that a complete calibration test and adjustment be performed 16 to 24 hours after power-up. Refer to zero and span calibration instructions in Section 3.4.



## 3. Operation

### 3.1 Programming Magnet Operating Instructions

The Operator Interface of the Model 700 Series gas sensors is accomplished via two internal magnetic switches located to either side of the LED display (see Figure 12). The two switches, labeled “PGM1” and “PGM2”, allow for complete calibration and configuration, thereby eliminating the need for area de-classification or the use of hot permits.



**Figure 11** Magnetic Programming Tool

The magnetic programming tool (Figure 11 **Magnetic Programming Tool**) is used to operate the magnetic switches. Switch action is defined as momentary contact, 3-second hold, and 10-second hold. (Hold times are defined as the time from the point when the arrow-prompt “▶” appears.) For momentary contact use, the programming magnet is briefly held over a switch location. For 3-second hold, the programming magnet is held in place over the switch location for three seconds. For 10-second hold, the programming magnet is held in place over the switch location for 10 seconds. The 3 and 10 second holds are generally used to enter calibration/program menus and save new data. The momentary contact is generally used to move between menu items and to modify set-point values. Arrows (“▶” and “◀”) are used on the LED display to indicate when the magnetic switches are activated. The location of “PGM1” and “PGM2” are shown in Figure 12.

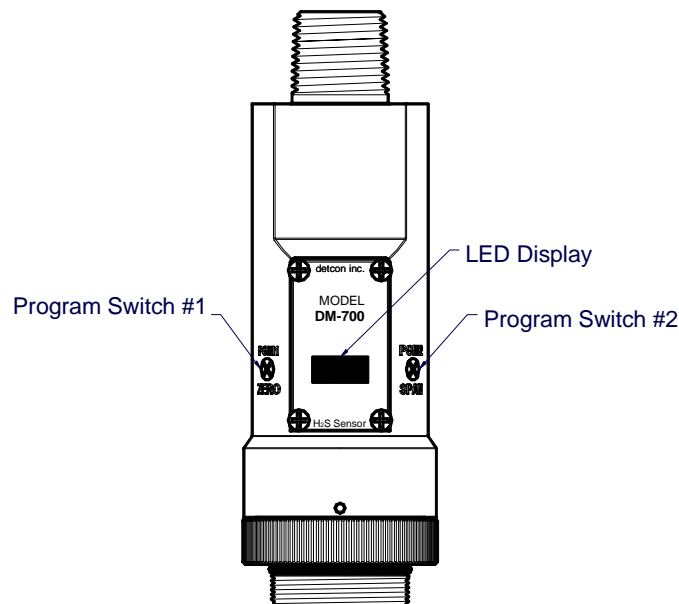

**Figure 12** Magnetic Programming Switches

---

**NOTE:** While in the Program Mode, if there is no magnetic switch interaction after 4 consecutive menu scrolls, the sensor will automatically revert to normal operating condition. While changing values inside menu items, **if there is no magnet activity after 3-4 seconds the sensor will revert to the menu scroll.**  
*(Exception to this is with “Signal Output Check” mode.)*

---

## 3.2 Operator Interface

The operating interface is menu-driven via the two magnetic program switches located under the target marks of the sensor housing. The two switches are referred to as “PGM1” and “PGM2”. The menu list consists of three major items that include sub-menus as indicated below. (Refer to the complete Software Flow Chart Figure 13.)

### Normal Operation

Current Reading and Gas Type/Fault Status

### Calibration Mode

AutoZero  
AutoSpan

### Program Mode

View Sensor Status  
    Sensor Model Type  
    Current Software Version  
    Gas Type  
    Range of Detection  
    Serial ID address  
    AutoSpan Level  
    Days Since Last AutoSpan  
    Remaining Sensor Life  
    mA Output  
    Input Voltage Supply  
    Sensor Temperature  
    Output  
    Bias Voltage  
    Gain Setting  
    Raw Counts  
Set AutoSpan Level  
Set Serial ID  
Set Range  
Signal Output Check  
Restore Default Settings

## Software Flowchart

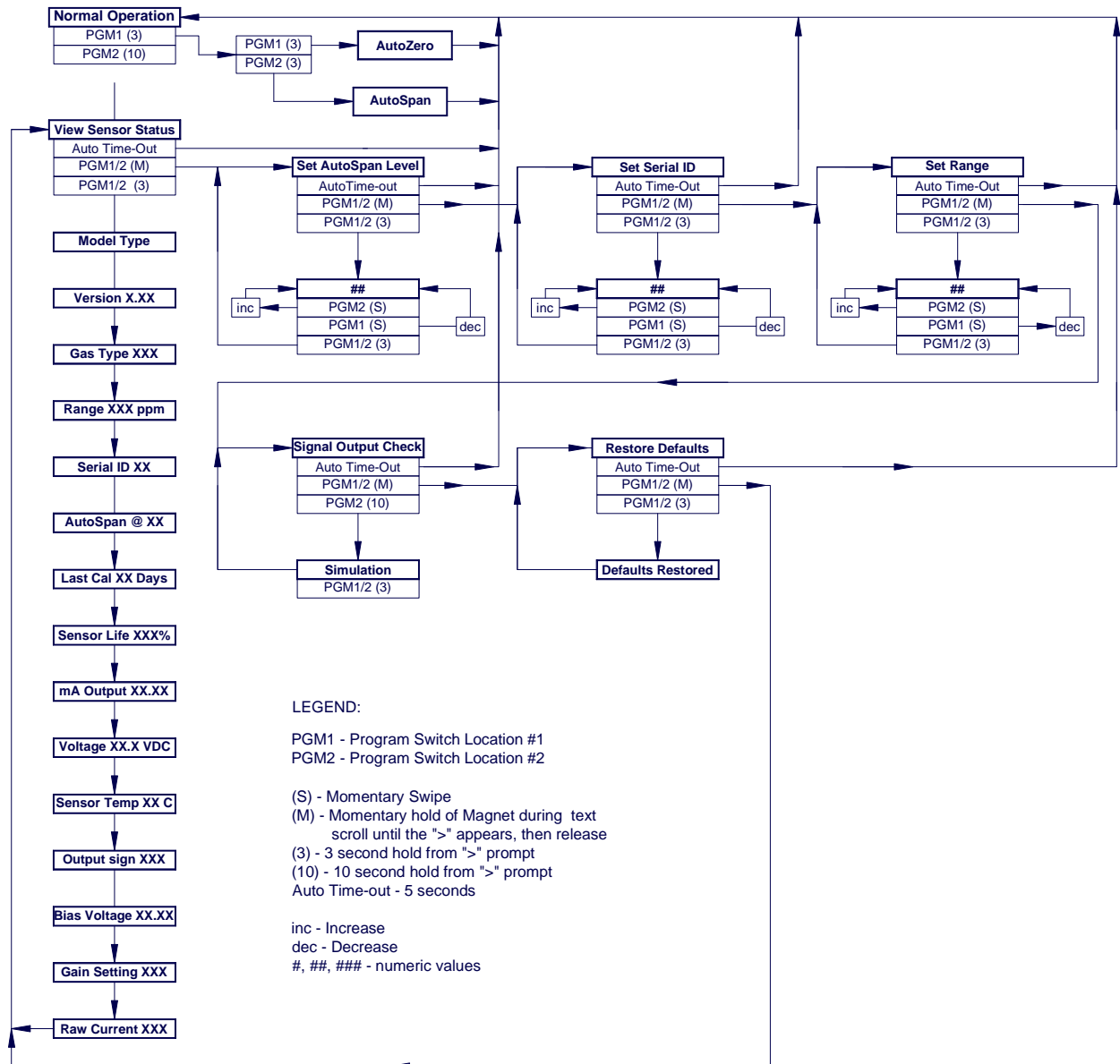

Figure 13 DM-700 Software Flowchart

### 3.3 Normal Operation

In normal operation, the ITM Display continuously shows the current sensor reading, which will normally appear as " 0 ". Once every 60 seconds the LED display will flash the sensor's measurement units and gas type (i.e. ppm H<sub>2</sub>S). If the sensor is actively experiencing any diagnostic faults, a "Fault Detected" message will scroll across the display on the ITM display once every minute instead of the units of measure and the gas type. At any time, while the sensor is in "Fault Detected" mode, PGM1 or PGM2 can be swiped to prompt the sensor to display a list of the active faults.

In normal operation, the 4-20mA current output linearity corresponds with the full-scale range. The RS-485 Modbus™ serial output provides the current gas reading and complete fault status on a continuous basis when polled by the master device.

## 3.4 Calibration Mode

### 3.4.1 AutoZero

The AutoZero function is used to zero the sensor. AutoZero should be performed periodically or as required. AutoZero should be considered after periods of over-range target gas exposure. Local ambient air can be used to zero calibrate a toxic gas sensor as long as it can be confirmed that it contains no target or interference gasses. If this cannot be confirmed then a zero air or N<sub>2</sub> cylinder should be used. Pure N<sub>2</sub> must be used for zero calibration of the O<sub>2</sub> deficiency sensors.

#### Material Requirements:

- Detcon PN 327-000000-000 MicroSafe™ Programming Magnet
- Detcon PN 613-120000-700 700 Series Splash Guard with integral Cal Port and Calibration Wind Guard (P/N 943-000000-000) -OR-
- Detcon PN 943-000006-132 Threaded Calibration Adapter
- Detcon PN 942-001123-000 Zero Air cal gas (or use ambient air if no target gas is present).
- Detcon P/N 942-640023-100 Nitrogen 99.99%

---

**NOTE 1:** The zero gas source may be zero air or N<sub>2</sub> for toxic sensors, but must be pure N<sub>2</sub> (99.99%) for O<sub>2</sub> deficiency sensors

---

---

**NOTE 2:** The Calibration Wind Guard must be used when the Splashguard Adapter with integral Cal Port is used. Failure to use the Calibration Wind Guard may result in an inaccurate AutoZero calibration.

---

- a) For toxic sensors, if the ambient air is known to contain no target gas content, then it can be used for zero calibration. If a zero gas cal cylinder is going to be used, attach the calibration adapter and set flow rate of 200-500cc/min (500cc/min is the recommended flow rate) and let sensor purge for 1-2 minutes before executing the AutoZero. For O<sub>2</sub> deficiency sensors, apply N<sub>2</sub> at a set flow rate of 500cc/min for 3-5 minutes before executing AutoZero.
- b) From Normal Operation, enter Calibration Mode by holding the programming magnet over PGM1 for 3 seconds. Note, the “◆” prompt will show that the magnetic switch is activated during the 3 second hold period. The display will then scroll “PGM1=AutoZero ...PGM2=AutoSpan”. Hold the programming magnet over PGM1 for 3 seconds once the “◆” prompt appears to execute AutoZero (or allow to timeout in 5 seconds if AutoZero is not desired).

---

**NOTE:** Upon entering Calibration Mode, the 4-20mA signal drops to 2mA and is held at this level until the program returns to normal operation. Modbus™ Status Register bit 14 is also set to signify when the sensor is in-calibration mode.

---

- c) The ITM will display the following sequence of text messages as it proceeds through the AutoZero sequence:

**Zero Cal . . . Setting Zero . . . Zero Saved** (each will scroll twice)

- d) Remove the zero gas and calibration adapter, if applicable.

### 3.4.2 AutoSpan

The AutoSpan function is used to span calibrate the sensor. AutoSpan should be performed periodically or as required. AutoSpan should be considered after periods of over-range target gas exposure. Unless otherwise specified, span adjustment is recommended at 50% of range. This function is called “AUTO SPAN”.

---

**NOTE:** Before performing AutoSpan Calibration, verify that the AutoSpan level matches the span calibration gas concentration as described in Section 3.5.2 Set AutoSpan Level.

---

**Material Requirements:**

- Detcon PN 327-000000-000 MicroSafe™ Programming Magnet
- Detcon PN 613-120000-700 700 Series Splash Guard with integral Cal Port -OR-
- Detcon PN 943-000006-132 Threaded Calibration Adapter
- Detcon Span Gas (See Detcon for Ordering Information). Recommended span gas is 50% of range with target gas. Other suitable span gas sources containing the target gas in air or N<sub>2</sub> balance are acceptable.

---

**NOTE 1:** Contact Detcon for Ordering Information on Span Gas cylinders.

---

---

**NOTE 2:** A target gas concentration of 50% of range is strongly recommended. This should be supplied at a controlled flow rate of 200 to 500cc/min, with 500cc/min being the recommended flow rate. Other concentrations can be used if they fall within allowable levels of 5% to 100% of range.

---

---

**NOTE 3:** Ambient air should be used to calibrate O<sub>2</sub> deficiency sensors as long as the oxygen concentration is confirmed to be 20.9%

---

---

**NOTE 4:** It is generally not advised to use other gasses to cross-calibrate for span. Cross-calibration by use of other gasses should be confirmed by Detcon.

---

---

**NOTE 5:** The Calibration Wind Guard must be used when the Splashguard Adapter with integral Cal Port is used. Failure to use the Calibration Wind Guard may result in an inaccurate AutoSpan calibration.

---



**CAUTION:** Verification that the calibration gas level setting matches the calibration span gas concentration is required before executing “AutoSpan” calibration. These two numbers must be equal.

AutoSpan consists of entering Calibration Mode and following the menu-displayed instructions. The display will ask for the application of span gas in a specific concentration. The applied gas concentration must be equal to the calibration gas level setting. The factory default setting and recommendation for span gas concentration is 50% of range. If a span gas containing the recommended concentration is not available, other concentrations may be used as long as they fall between 5% and 100% of range. However, any alternate span gas concentration value must be programmed via the “**Set AutoSpan Level**” menu before proceeding with AutoSpan calibration. Follow the instructions “a” through “e” below for AutoSpan calibration.

- a) Verify that the AutoSpan Level is equal to the Calibration Span Gas Concentration. (Refer to View Sensor Status in Section 3.5.1.) If the AutoSpan Level is not equal to the Calibration span gas concentration, adjust the AutoSpan Level as instructed in Section 3.5.2 Set AutoSpan Level.
- b) From Normal Operation, enter Calibration Mode by holding the programming magnet over PGM1 for 3 seconds. Note, the “◆” prompt will show that the magnetic switch is activated during the 3 second hold period. The display will then scroll “**PGM1=AutoZero . . . PGM2=AutoSpan**”. Hold the programming magnet over PGM2 for 3 seconds to execute AutoSpan (or allow to timeout in 5 seconds if AutoSpan is not intended). The ITM will then scroll “**Apply XX ppm Gas**”.

---

**NOTE:** Upon entering Calibration Mode, the 4-20mA signal drops to 2mA and is held at this level until the program returns to normal operation. Modbus™ Status Register bit 14 is also set to signify when the sensor is in-calibration mode.

---

- c) Apply the span calibration test gas for toxic gas sensors at a flow rate of 200-500cc/min (500cc/min is the recommended flow rate). As the sensor signal begins to increase the display will switch to flashing “XX” reading as the ITM shows the sensor’s “as found” response to the span gas presented. If it fails to meet the minimum in-range signal change criteria within 2½ minutes, the display will report “**Range Fault**” twice and the ITM will return to normal operation, aborting the AutoSpan sequence. The ITM will continue to report a “Range Fault” and will not clear the fault until a successful AutoSpan is completed.

---

**NOTE:** Ambient air should be used to calibrate O<sub>2</sub> deficiency sensors as long as the oxygen concentration is confirmed to be 20.9%. There is no need to apply a flow of gas.

---

For about 1 minute the reading will auto-adjust to the programmed AutoSpan level. For about another 30 seconds, the AutoSpan sequence checks the sensor for acceptable reading stability. If the sensor fails the stability check, the reading is re-adjusted back to the AutoSpan level and the cycle repeats until the stability check is passed. Up to three additional 30-second stability check periods are allowed before the unit reports a “**Stability Fault**” twice and the ITM will return to normal operation, aborting the AutoSpan sequence. The ITM will continue to report a “**Stability Fault**” and will not clear the fault until a successful AutoSpan is completed.

If the sensor passes the stability check, the ITM reports a series of messages:

“Span OK”  
 “Sensor Life XXX%”  
 “Remove Span Gas”

- d) Remove the span gas source and calibration adapter. The ITM will report a live reading as it clears toward “0”. When the reading clears below 5% of range, the ITM will display “**Span Complete**” and will revert to normal operation. If the sensor fails to clear to less than 5% in less than 5 minutes, a “**Clearing Fault**” will be reported twice and the ITM will return to normal operation, aborting the AutoSpan sequence. The ITM will continue to report a “**Clearing Fault**” and will not clear the fault until a successful AutoSpan is completed.

---

**NOTE:** When calibrating O<sub>2</sub> deficiency sensors, there is no requirement to clear to <5% of range. The sensor will return to normal operation immediately after span adjustment.

---

- e) The AutoSpan calibration is complete.

---

**NOTE 1:** If the sensor fails the minimum signal change criteria, a “**Range Fault**” will be declared and a “**Fault Detected**” message will be displayed alternately with the sensor’s current reading. The 4-20mA output will be taken to 0mA and the ‘Range Fault’ fault bit will be set on the Modbus™ output.

---



---

**NOTE 2:** If the sensor fails the stability criteria, a “**Stability Fault**” will be declared and a “**Fault Detected**” message will be displayed alternately with the sensor’s current reading. The 4-20mA output will be taken to 0mA and the ‘Stability Fault’ fault bit will be set on the Modbus™ output.

---



---

**NOTE 3:** If the sensor fails the clearing time criteria, a “**Clearing Fault**” will be declared and a “**Fault Detected**” message will be displayed alternately with the sensor’s current reading. The

---

---

4-20mA output will be taken to 0mA and the 'Clearing Fault' fault bit will be set on the Modbus™ output.

---

### 3.5 Program Mode

Program Mode provides a “**View Sensor Status**” menu to check operational and configuration parameters. Program Mode provides for adjustment of the AutoSpan Level and Serial ID. Additionally, Program Mode includes the diagnostic function “Signal Output Check” and “Restore Factory Defaults”.

The Program Mode menu items appear in the order presented below:

- View Sensor Status
- Set AutoSpan Level
- Set Serial ID
- Set Range
- Signal Output Check
- Restore Default Settings

#### Navigating Program Mode

From Normal Operation, enter Program Mode by holding the magnet over PGM2 for 10 seconds. Note, the “**◆**” prompt will show that the magnetic switch is activated during the 10 second hold period. The ITM will enter Program Mode and the display will display the first menu item “View Sensor Status”. To advance to the next menu item, hold the magnet over PGM1 or PGM2 while the current menu item’s text is scrolling. At the conclusion of the text scroll the arrow prompt (“**◆**” for PGM2 or “**◆**” for PGM1) will appear, and immediately remove the magnet. The ITM will advance to the next menu item. Repeat this process until the desired menu item is displayed. Note, PGM1 moves the menu items from right to left and PGM2 moves the menu items from left to right.

To enter a menu item, hold the magnet over PGM1 or PGM2 while the menu item is scrolling. At the conclusion of the text scroll the “**◆**” prompt (“**◆**” for PGM2 or “**◆**” for PGM1) will appear, continue to hold the magnet over PGM1 or PGM2 for an additional 3-4 seconds to enter the selected menu item. If there is no magnet activity while the menu item text is scrolling (typically 4 repeated text scrolls), the ITM will automatically revert to Normal Operation.

#### 3.5.1 View Sensor Status

**View Sensor Status** displays all current configuration and operational parameters including: sensor type, software version number, gas type, detection range, AutoSpan level, days since last AutoSpan, estimated remaining sensor life, raw sensor current, mA output, input voltage and sensor ambient temperature.

From the **View Sensor Status** text scroll, hold the magnet over PGM1 or PGM2 until the “**◆**” prompt appears and continue to hold the magnet in place for an additional 3-4 seconds (until the display starts to scroll “Status Is”). The display will scroll the complete list of sensor status parameters sequentially:

#### Sensor Model Type

The menu item appears as: “Model DM-700”

#### Current Software Version

The menu item appears as: “Version 1.XX”

**Gas Type**

The menu item appears as: “ Gas Type = H2S”

**Range of Detection**

The menu item appears as: “Range XXX ppm”

**Serial ID address.**

The menu item appears as: “Serial ID XX”

**AutoSpan Level.**

The menu item appears as: “AutoSpan at XX ppm”

**Days Since Last AutoSpan.**

The menu items appears as: “Last Cal XX days”

**Remaining Sensor Life**

The menu item appears as: “Sensor Life 100%”

**mA Output**

The menu item appears as: “mA Output XX.XX”

**Input Voltage Supply**

The menu item appears as: “Voltage XX.X VDC”

**Sensor Temperature**

The menu item appears as: “Operating Temp XX C”

**Output**

The menu item appears as: “Output X”

**Bias Voltage**

The menu item appears as: “Bias Voltage XXXmV”

**Gain Setting**

The menu item appears as: “Gain Setting XX”

**Raw Counts**

The menu item appears as: “Raw Counts XXXX”

When the status list sequence is complete, the ITM will revert to the “View Sensor Status” text scroll. The user can either: 1) review list again by executing another 3-4 second hold, 2) move to another menu item by executing a momentary hold over PGM1 or PGM2, or 3) return to Normal Operation via automatic timeout of about 15 seconds (the display will scroll “View Sensor Status” 4 times and then return to Normal Operation).



### 3.5.2 Set AutoSpan Level

**Set AutoSpan Level** is used to set the span gas concentration level that is being used to calibrate the sensor. This level is adjustable from 1% to approximately 75% or 95% dependent on full-scale range. The current setting can be viewed in View Program Status.

The menu item appears as: “**Set AutoSpan Level**”

From the **Set AutoSpan Level** text scroll, hold the magnet over PGM1 or PGM2 until the “**▶**” prompt appears and continue to hold the magnet in place for an additional 3-4 seconds (until the display starts to scroll “Set Level”). The display will switch to “XX” (where XX is the current gas level). Swipe the magnet momentarily over PGM2 to increase or PGM1 to decrease the AutoSpan Level until the correct level is displayed. When the correct level is achieved, hold the magnet over PGM1 or PGM2 for 3-4 seconds to accept the new value. The display will scroll “Level Saved”, and revert to “Set AutoSpan Level” text scroll.

Move to another menu item by executing a momentary hold, or return to Normal Operation via automatic timeout of about 15 seconds (the display will scroll “Set AutoSpan Level” 4 times and then return to Normal Operation).

### 3.5.3 Set Serial ID

Detcon Model DM-700 sensors can be polled serially via RS-485 Modbus™ RTU. Refer to Section 4.0 for details on using the Modbus™ output feature.

**Set Serial ID** is used to set the Modbus™ serial ID address. It is adjustable from 01 to 256 in hexadecimal format (01-FF hex). The current serial ID can be viewed in View Sensor Status using the instruction given in Section 3.5.1 View Sensor Status.

The menu item appears as: “**Set Serial ID**”.

From the “**Set Serial ID**” text scroll, hold the programming magnet over PGM1 or PGM2 until the “**▶**” prompt appears and continue to hold the magnet in place for an additional 3-4 seconds (until the display starts to scroll “Set ID”). The display will then switch to “XX” (where XX is the current ID address). Swipe the magnet momentarily over PGM2 to increase or PGM1 to decrease the hexadecimal number until the desired ID is displayed. Hold the magnet over PGM1 or PGM2 for 3-4 seconds to accept the new value. The display will scroll “ID Saved”, and revert to “Set Serial ID” text scroll.

Move to another menu item by executing a momentary hold, or, return to Normal Operation via automatic timeout of about 15 seconds (the display will scroll “Set Serial ID” 5 times and then return to Normal Operation).

### 3.5.4 Set Range

The full-scale range of a DM-700 sensor is determined at the time of order. The Intelligent Plug-in Sensor is factory calibrated for this range. However, if the application requirements change and the user needs to alter the original range, the “Set Range” function can be used to make field adjustments.

The currently selected full-scale range is displayed in the “**View Sensor Status**” menu. The factory calibrated full-scale range is printed on the Intelligent Plug-in Sensor Label. When a new range is selected the 4-20mA and Modbus™ outputs will automatically be rescaled, and the span gas level will default to 50% of the new range.

The menu item appears as: “**Set Range**”

From the “**Set Range**” text scroll, hold the programming magnet over PGM1 or PGM2 until the “**◆**” prompt appears and continue to hold the magnet in place for an additional 3-4 seconds (until the display starts to scroll “**Set Range**”). The display will then switch to “**XXX**”(where **XXX** is the current Range). Swipe the magnet momentarily over PGM2 to increase or PGM1 to decrease the range Level until the desired range is displayed. Hold the magnet over PGM1 or PGM2 for 3 seconds to accept the new value. The display will scroll “**Range Saved**”, and revert to “**Set Range**” text scroll.

Selectable ranges are:

1, 2, 3, 4, 5, 6, 7, 8, 9, 10  
15, 20, 25, 30, 35, 40, 45, 50, 55, 60, 65, 70, 75, 80, 85, 90, 95, 100  
150, 200, 250, 300, 350, 400, 450, 500, 600, 700, 800, 900, 1000  
2000, 3000, 4000, 5000, 6000, 7000, 8000, 9000, 10,000

The range can only be changed to a new range that is between 4 times greater or 4 times less than that of the current plug-in sensor. I.E. For a plug-in sensor of 100ppm, the range can be set as low as 25ppm or as high as 400ppm.

Move to another menu item by executing a momentary hold, or, return to Normal Operation via automatic timeout of about 15 seconds (the display will scroll “**Set Range**” 4 times and then return to Normal Operation).

---

**NOTE1:** The sensor should be re-calibrated after any change is made to the sensor range. AutoSpan and AutoZero should be re-established.

---

---

**NOTE2:** When a new plug-in sensor is installed, the ITM will automatically default to the range of the plug-in sensor.

---

### 3.5.5 Signal Output Check

**Signal Output Check** provides a simulated 4-20mA output and RS-485 Modbus™ output. This simulation allows the user to conveniently perform a functional system check of their entire safety system. This signal output simulation also aids the user in performing troubleshooting of signal wiring problems.

The menu item appears as: “**Signal Output Check**”.

From the “**Signal Output Check**” text scroll, hold the magnet over PGM1 or PGM2 until the “**◆**” prompt appears and then hold continuously for an additional 10 seconds. Once initiated, the display will scroll “**Simulation Active**” until the function is stopped. During simulation mode, the 4-20mA value will be increased from 4.0mA to 20.0mA (in 1% of range increments at about a 1 second update rate) and then decreased from 20.0mA to 4.0mA. The same simulation sequence is applied to the Modbus™ output gas reading.

---

**NOTE:** Signal Output Check stays active indefinitely until the user stops the function. There is no automatic timeout for this feature.

---

To end simulation mode, hold magnet over PGM1 or PGM2 for 3 seconds. The display will either move to the prior menu item or move to the next menu item respectively.

Move to another menu item by executing a momentary hold, or, return to Normal Operation via automatic timeout of about 15 seconds.

### 3.5.6 Restore Factory Defaults

**Restore Factory Defaults** is used to clear current user configuration and calibration data from memory and

revert to factory default values. This may be required if the settings have been configured improperly and a known reference point needs to be re-established to correct the problem.

This menu item appears as: “**Restore Defaults**”.

---

**NOTE:** Restoring factory defaults should only be used when absolutely necessary. All previously existing configuration inputs will have to be re-entered if this function is executed. A full 10-second magnet hold on PGM 2 is required to execute this function.

---

From the “**Restore Defaults**” text scroll, hold the programming magnet over PGM2 until the “**◆**” prompt appears and continue to hold 10 seconds. The display will scroll “**Restoring Defaults**”, followed by “**New ECS Connected**”, and “**Range XX**” where XX is the default range of the intelligent plug-in sensor.

Move to another menu item by executing a momentary hold, or, return to Normal Operation via automatic timeout of about 15 seconds (the display will scroll “Restore Defaults” 4 times and then return to Normal Operation).

Following the execution of “**Restore Defaults**”, the DM-700 will revert to its factory default settings. The default settings are:

- Serial ID = 01. The Serial ID must be set appropriately by the operator (Section 3.5.3).

---

**NOTE:** The following must be performed in order before the sensor can be placed in operation.

---

- AutoSpan Level = 50% of range. AutoSpan level must be set appropriately by the operator (Section 3.5.2).
- Range: Defaults to range of intelligent plug-in sensor, must be set to the appropriate level by the operator (Section 3.5.4).
- AutoZero: AutoZero Settings are lost and user must perform new AutoZero (Section 3.4).
- AutoSpan: AutoSpan Settings are lost and user must perform new AutoSpan (Section 3.4).

## 3.6 Program Features

Detcon DM-700 toxic gas sensors incorporate a comprehensive set of diagnostic features to achieve Fail-Safe Operation. These Operational features and Failsafe Diagnostic features are detailed below.

### 3.6.1 Operational Features

#### Over-Range

When gas greater than the full-scale range is detected, the ITM display will continuously flash the full-scale reading. This designates an over-range condition. The 4-20mA signal will report a 22mA output during this time.

#### Negative Drift

In cases where the sensor may drift negative, the display will show a negative reading between 5% and 10% of the sensors full scale range; I.E. if a 0-100ppm sensor drifts to negative 6 the display will indicate -6. In cases where the full scale range of the sensor is less than 10ppm, due to the limited space on the display, the decimal point will be displayed as an asterisk (\*) to denote a negative reading. I.E. if a 0-5ppm sensor drifts to negative 0.32 the display will show 0\*32.

## In-Calibration Status

When the sensor is engaged in AutoZero or AutoSpan calibrations, the 4-20 mA output signal is taken to 2.0 mA and the in-calibration Modbus™ Status Register bit 14 is set. This alerts the user that the ITM is not in an active measurement mode. This feature also allows the user to log the AutoZero and AutoSpan events via their master control system.

## Sensor Life

Sensor Life is calculated after each AutoSpan calibration and is reported as an indicator of remaining service life. It is reported in the “View Sensor Status” menu and as a RS-485 Modbus™ register bit. Sensor Life is reported on a scale of 0-100%. When Sensor Life falls below 25%, the sensor cell should be replaced within a reasonable maintenance schedule.

## Last AutoSpan Date

This reports the number of days that have elapsed since the last successful AutoSpan. This is reported in the View Sensor Status menu. After 180 days, an AutoSpan Fault will be declared.

## 3.6.2 Fault Diagnostic/Failsafe Features

### Fail-Safe/Fault Supervision

Model DM-700 sensors are designed for Fail-Safe operation. If any of the diagnostic faults listed below are active, the ITM Display will scroll the message “Fault Detected” every 1 minute during normal operation. At any time during “Fault Detected” mode, holding the programming magnet over PGM1 or PGM2 for 1 second will display the active fault(s). All active faults are reported sequentially.

Most fault conditions result in failed operation of the sensor. In these cases the 4-20mA signal is dropped to the universal fault level of 0mA. These include the AutoSpan Calibration faults, Heater Fault, Sensor Fault, Processor Fault, Memory Fault, Loop Fault, and Input Voltage Fault. The 0mA fault level is not employed for Temperature or AutoSpan Faults. For every diagnostic fault condition the associated RS-485 Modbus™ fault register will be flagged to alert the user digitally.

---

**NOTE:** Refer to the Troubleshooting Guide section for guidance on how to address fault conditions.

---

### Range Fault – AutoSpan

If the sensor fails the minimum signal change criteria (Section 3.4.2) during AutoSpan sequence, the “Range Fault” will be declared. A “Range Fault” will cause a “Fault Detected” message to flash intermittently on the ITM display and drop the 4-20mA output to 0mA. The Modbus™ fault register bit for Range Fault will be set and will not clear until the fault condition has been cleared. The sensor should be considered ‘Out-of-Service’ until a successful AutoSpan calibration is performed.

### Stability Fault - AutoSpan

If the sensor fails the signal stability criteria (Section 3.4.2) during AutoSpan sequence, the “Stability Fault” will be declared. A “Stability Fault” will cause a “Fault Detected” message to flash intermittently on the ITM display and drop the mA output to 0 mA. The Modbus™ fault register bit for Stability Fault will be set and will not clear until the fault condition has been cleared. The sensor should be considered as ‘Out-of-Service’ until a successful AutoSpan calibration is performed.

### **Clearing Fault - AutoSpan**

If the sensor fails the signal stability criteria (Section 3.4.2) during AutoSpan sequence, the “Clearing Fault” will be declared. A “Clearing Fault” will cause a “Fault Detected” message to flash intermittently on the ITM display and drop the mA output to 0 mA. The Modbus™ fault register bit for Clearing Fault will be set and will not clear until the fault condition has been cleared. The sensor should be considered as ‘Out-of-Service’ until a successful AutoSpan calibration is performed.

### **Zero Fault**

If the sensor drifts to < -10% of range, an “Under-Range Fault” will be declared. An “Under-Range Fault” will cause a “Fault Detected” message to flash intermittently on the ITM display. The Modbus™ fault register bit for Under-Range Fault will be set and will not clear until the fault condition has been cleared. If an Under-Range Fault occurs, the 4-20 mA signal will be set at 0mA until the fault condition is resolved.

### **Sensor Fault**

If the intelligent plug-in sensor is not plugged in, plugged in incorrectly, or there is a communication failure, a “Sensor Fault” is declared. A “Sensor Fault” will cause a “Fault Detected” message to flash intermittently on the ITM display. The Modbus™ fault register bit for Sensor Fault will be set and will not clear until the fault condition has been cleared. If a Sensor Fault occurs, the 4-20mA signal will be set at 0mA until the fault condition is resolved.

### **Processor Fault**

If the detector has any unrecoverable run-time errors, a “Processor Fault” is declared. A “Processor Fault” will cause a “Fault Detected” message to flash intermittently on the ITM display. The Modbus™ fault register bit for Processor Fault will be set and will not clear until the fault condition has been cleared. If a Processor Fault occurs, the 4-20 mA signal will be set at 0mA until the fault condition is resolved.

### **Memory Fault**

If the detector has a failure in saving new data to memory, a “Memory Fault” is declared. A “Memory Fault” will cause the “Fault Detected” message to flash intermittently on the ITM display. The Modbus™ fault register bit for Memory Fault will be set and will not clear until the fault condition has been cleared. If a Memory Fault occurs, the 4-20mA signal will be set at 0mA until the fault condition is resolved.

### **4-20 mA Loop Fault**

If the sensor detects a condition where the 4-20mA output loop is not functional (high loop resistance or failed circuit function) a “4-20mA Fault” is declared. A “4-20mA Fault” will cause the “Fault Detected” message to scroll once a minute on the ITM display. The Modbus™ fault register bit for Loop Fault will be set and will not clear until the fault condition has been cleared. If a Loop Fault occurs, the 4-20mA signal will be set at 0mA until the fault condition is resolved. If the 4-20mA current loop is still out of tolerance, contact Detcon at [Service@detcon.com](mailto:Service@detcon.com), or contact Detcon customer service.

### **Input Voltage Fault**

If the detector is currently receiving an input voltage that is outside of the 11.5-28VDC range, an “Input Voltage Fault” is declared. An “Input Voltage Fault” will cause the “Fault Detected” message to flash intermittently on the ITM display. The fault register bit for Input Voltage Fault will be set and will not clear until the fault condition has been cleared. If an Input Voltage Fault occurs, the 4-20mA signal will be set at 0mA until the fault condition is resolved.

## Temperature Fault

If the detector is currently reporting an ambient temperature that is outside of the  $-40\text{C}^{\circ}$  to  $+75\text{C}^{\circ}$  range a “Temperature Fault” is declared. A “Temperature Fault” will cause the “Fault Detected” message to flash intermittently on the ITM display. The Modbus™ fault register bit for Temperature Fault will be set and will not clear until the fault condition has been cleared. If a Temperature Fault occurs, the 4-20mA signal remains operational.

## AutoSpan Fault

If 180 days has elapsed since the last successful AutoSpan, an AutoSpan Fault will be generated. An “AutoSpan Fault” will cause the “Fault Detected” message to flash intermittently on the ITM display. The Modbus™ fault register bit for AutoSpan Fault will be set and will not clear until the fault condition has been cleared by executing a successful AutoSpan. If an AutoSpan occurs, the 4-20mA signal remains operational.

## 4. RS-485 Modbus™ Protocol

Model DM-700 sensors feature Modbus™ compatible communications protocol and are addressable via the program mode. Other protocols are available. Contact the Detcon factory for specific protocol requirements. Communication is two wire, half duplex 485, 9600 baud, 8 data bits, 1 stop bit, no parity, with the sensor set up as a slave device. A master controller up to 4000 feet away can theoretically poll up to 256 different sensors. This number may not be realistic in harsh environments where noise and/or wiring conditions would make it impractical to place so many devices on the same pair of wires. If a multi-point system is being utilized, each sensor should be set for a different address. Typical address settings are: 01, 02, 03, 04, 05, 06, 07, 08, 09, 0A, 0B, 0C, 0D, 0E, 0F, 10, 11...etc.

Sensor RS-485 ID numbers are factory default to 01. These can be changed in the field via the Operator Interface described in Section 3.5.5 Set Serial ID.

The following section explains the details of the Modbus™ protocol that the DM-700 sensor supports.

Code 03 - Read Holding Registers is the only code supported by the transmitter. Each transmitter contains 6 holding registers which reflect its current status.

**Table 2** Modbus™ Registers

FC	REG	Content Description	R/W	Content Definition		
				Value	Meaning	Range
03	40000	Device Type	R	8	700 Sensor	
03 06	40001 40001	Read Detectable Range <sup>1,2</sup> Write Detectable Range	R/W	100 10000	For 0-100 For 0-10000 <sup>2</sup>	DM – 0 to 10000 FP – Read only TP – 20, 50, 100, 200 IR – 0 to 10000 PI – 0 to 10000
03	40002	Read Concentration <sup>3,2</sup>	R	1000	Bound by range. If > range, this value is in fault.	
03 06	40003 40003	Read AutoSpan Level <sup>4,2</sup> Write AutoSpan Level	R/W	50	Span gas at 50	DM – 1% to 95% of Range (40001) FP – 5% to 95% of Range (40001) TP – 2% to 50% of Range (40001) IR – 5% to 95% of Range (40001) PI – 1% to 95% of Range (40001)
03	40004	Read Sensor Life	R	85	For 85% sensor life	
03	40005	Read Fault Status Bits <sup>5</sup>	R	0x0001 0x0002 0x0004 0x0008 0x0010 0x0020 0x0040 0x0080 0x0100 0x0200 0x0400 0x0800 0x1000 0x2000 0x4000 0x8000	Global Fault Auto Span Fault Temperature Fault 4-20mA Fault Input Voltage Fault Memory Fault Processor Fault Clearing Fault Stability Fault Range Fault Sensor Fault Zero Fault Sensor Fault 2 <reserved> In Calibration Communication Error	
03	40006	Read Model #	R	1, 2, 3, 4, 5	DM, FP, IR, TP, PID respectively	
03	40007	Read Days Since Cal	R	29	29days	
03	40008	4-20 Current Output mA x100	R	400	4.00mA	<b>Range</b>
03	40009	Read Input Voltage V x100	R	2400	24.00V	
03	40010	Read Temperature	R	28	28 °C	
03/ 06	40011	Special #1	R/W		Function dependent on value of 40006 (See Special Register Table 3)	

FC	REG	Content Description	R/W	Content Definition		
				Value	Meaning	Range
03/06	40012	Special #2	R/W		Function dependent on value of 40006 (See Special Register Table 3)	
03	40013	Special #3	R		Function dependent on value of 40006 (See Special Register Table 3)	
03/06	40014	Special #4	R/W		Function defendant on value of 40006 (See Special Register Table 3)	
03	40015	Calibration Status	R	0x0000 0x0001 0x0002 0x0003 0x0004	Idle Zero Calibration Started Span Calibration Started Span Set	
06	40015	Calibration Enable	W	0x0001 0x0002 0x0008 0x0009 0x000A 0x000B	Set Zero Set Span Signal simulation mode Set FP Bridge Voltage Set TP Heater Power Set IR Gain	
03	40016	Read Text 1, first char in L	R		Two Char of Gas/Units String <sup>6</sup>	
03	40017	Read Text 2	R		Two Char of Gas/Units String <sup>6</sup>	
03	40018	Read Text 3	R		Two Char of Gas/Units String <sup>6</sup>	
03	40019	Read Text 4	R		Two Char of Gas/Units String <sup>6</sup>	
03	40020	Read Text 5, last char in H	R		Two Char of Gas/Units String <sup>6</sup>	
03	40021	Text null terminator in L	R		Two Char of Gas/Units String <sup>6</sup>	

<sup>1</sup> Integer ranges from 1 all the way to 10,000.

<sup>2</sup> Units are determined by “units” field in the “notation” string

<sup>3</sup> Gas Reading times one (x 1) with units in notation string for “Low Range” = 0. Gas Reading times one (x 10) with units in notation string for “Low Range” = 1. Gas Reading times one (x 100) with units in notation string for “Low Range” = 2.

<sup>4</sup> Span Gas must be less than or equal to Detectable Range and is usually about ½ of it.

<sup>5</sup> Fault status bits self-reset when fault clears

<sup>6</sup> Text in ASCII, in order L byte, H byte, L byte... See field descriptions of notation string.

Gas/Units String

Character #	1	2	3	4	5	6	7	8	9	10	11
Description	Units			0x20	Gas Type						0x00

Units – This field is ‘PPM’, ‘PPB’, or ‘\_ \_ %’ (where ‘\_ \_’ is a space, 0x20).

0x20 – The units filed is terminated with an ASCII space (0x20)

Gas Type – This field contains the gas type of the cell. Any ASCII string is permissible

0x00 – The notation string is terminated with an ASCII null character

**Table 3** Modbus™ Special Registers

REG	DM (40006 = 1)	FP (40006 = 2)	IR (40006 = 3)	TP (40006 = 4) <sup>1</sup>	PI (40006 = 5)
40011	Low Range= 0, 1, 2 0: Range >25 (0 decimal place) 1: Range 10-25 (1 decimal place) 2: Range <10 (2 decimal place)	Gas Factor (R/W) <b>Range = 79 to 565</b>	Gas Factor (R/W) <b>Range = 20 to 565</b>	Heater Power (mW) (R/W)	Low Range= 0, 1, 2 0: Range >25 1: Range 10-25 2: Range <10
40012	0x8XXX Positive Polarity Cell 0x0XXX Negative Polarity Cell 0xX000 Bias = 0mV 0xX096 Bias = 150mV 0xX0C8 Bias = 200mV 0xX12C Bias = 300mV	Cal Factor (R/W) <b>Range = 79 to 565</b>	Active Counts	Heater Voltage (mV)	0x8XXX Positive Polarity Cell 0x0XXX Negative Polarity Cell 0xX096 Bias = 0mV 0xX0C8 Bias = 150mV 0xX12C Bias = 200mV Bias = 300mV
40013	Gain Code (integer between 0 & 15)	Bridge Current (mA)	Reference Counts	Sensor Resistance (x100 Ω)	Gain Code
40014	Raw Counts 0-0xFFFF (0x8000 = nominal 0)	Bridge Voltage (mV) (Read only)	Range Divisor 1,10,100, or 1000	Heater Current (mA)	Raw Counts

<sup>1</sup> Only possible ranges are 20, 50, 100, 200. Modbus register 40001 will contain either 20, 50, 100, or 200, range divisor is not necessary.



## 5. Service and Maintenance

### 5.1 Calibration Frequency

In most applications, quarterly span calibration intervals will assure reliable detection. However, industrial environments differ. Upon initial installation and commissioning, close frequency tests should be performed, weekly to monthly. Test results should be recorded and reviewed to determine a suitable calibration interval. If, after 180 days, an AutoSpan Calibration is not performed, the ITM will generate an AutoSpan Fault.

### 5.2 Visual Inspection

The Sensor should be inspected annually. Inspect for signs of corrosion, pitting, and water damage. During visual inspection, the Splash Guard should be inspected to insure that it is not blocked. Examine the plug-in sensor for signs of physical blockage, electrolyte leakage, or severe corrosion. Also, inspect inside the Junction Box for signs of water accumulation or Terminal Block corrosion.

### 5.3 Condensation Prevention Packet

A moisture condensation packet should be installed in every explosion proof Junction Box. The moisture condensation prevention packet will prevent the internal volume of the J-Box from condensing and accumulating moisture due to day-night humidity changes. This packet provides a critical function and should be replaced annually. Detcon's PN is 960-202200-000.

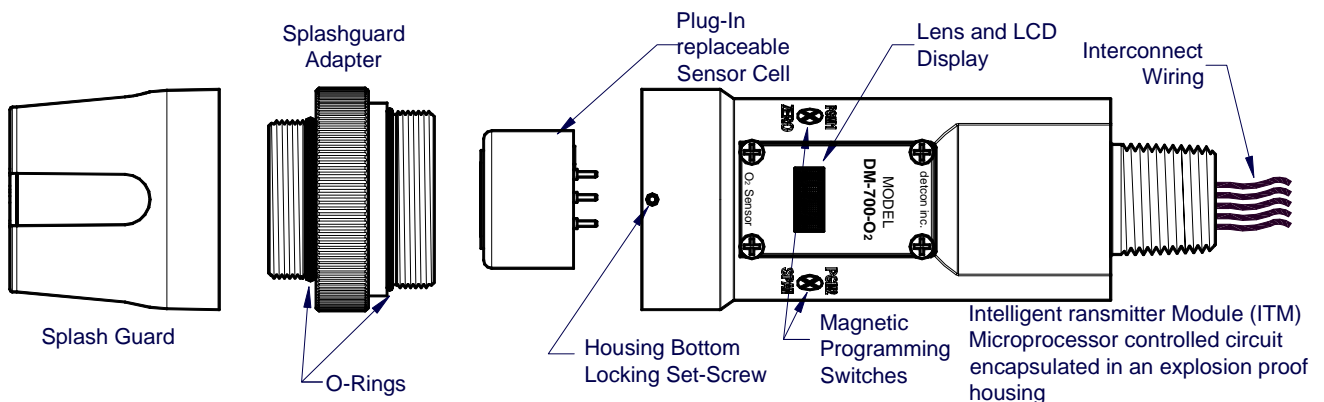
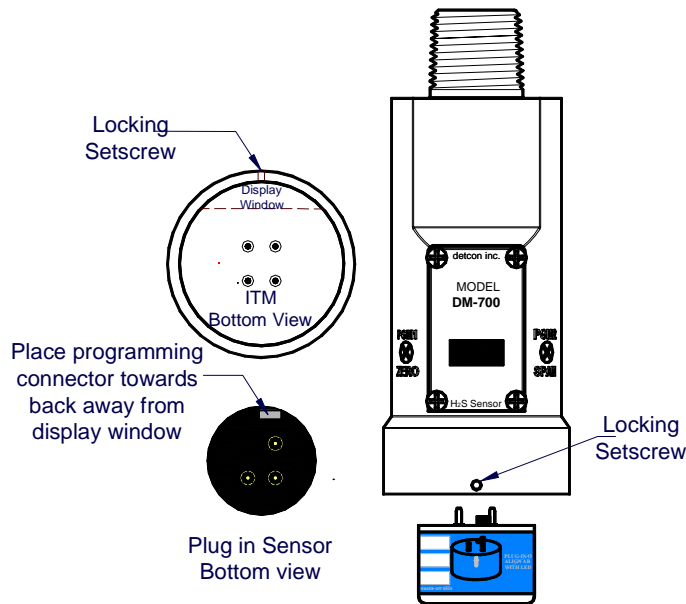

Figure 14 Sensor Assembly

### 5.4 Replacement of Intelligent Plug-in Sensor

**NOTE:** It is not necessary to remove power while changing the plug-in toxic gas sensor in order to maintain area classification, since it is intrinsically safe.

- a) Use a 1/16" Allen wrench to release the locking setscrew that locks the ITM and Splash Guard Adapter together (One turn will suffice - Do not remove setscrew completely).
- b) Remove splashguard. Unthread and remove the Splash Guard Adapter from the ITM.
- d) Gently pull the plug-in sensor out of the ITM. Orient the new plug-in sensor so that it matches with the female connector pins. Use the alignment marks provided to assure alignment is correct. When properly aligned, press the sensor in firmly to make the proper connection.



**Figure 15** Sensor Cell and ITM Mating

e) Thread the Splash Guard Adapter onto the ITM to a snug fit and tighten the locking setscrew using the 1/16” Allen wrench. Reinstall the splashguard.

f) Verify the gas type and range of the new sensor by checking in View Program Status. It is recommended “AutoZero and AutoSpan functions be performed, as per Section 3.4 Calibration Mode, to match the new intelligent plug-in sensor with the ITM.

## 5.5 Replacement of ITM

a) Remove the power source from the sensor assembly. Disconnect all sensor wire connections at the J-Box taking note of the wire connections.

**NOTE:** It is necessary to remove power to the J-Box while changing the ITM in order to maintain area classification.

b) Use a wrench and the wrench flats provided at the top section of the ITM and unthread the ITM until it can be removed.

c) Use a 1/16” Allen wrench to release the locking setscrew that locks the ITM and Splash Guard Adapter together (One turn will suffice - Do not remove setscrew completely).

d) Remove splashguard. Unthread and remove the Splash Guard Adapter from the ITM.

e) Gently remove the plug-in toxic gas sensor from the old ITM and install it in the new ITM. Orient the plug in sensor so that it matches with the female connector pins on the new ITM, placing the programming connector to the back and press the sensor in firmly to make proper connection.

f) Thread the Splash Guard Adapter onto the ITM until snug, tighten the locking setscrew and reconnect splashguard.

g) Feed the sensor assembly wires through the 3/4” female NPT mounting hole and thread the assembly into the J-box until tight and the ITM lens faces toward the front access point. Connect the sensor assembly wires inside J-Box (Refer to Section 2.6, and Figure 10).

h) Perform Set AutoSpan Level, Set Serial ID, Set Range, and then perform a successful AutoZero and AutoSpan before placing sensor into service.

## 5.6 Replacement of DM-700 Sensor Assembly

a) Remove the power source from the sensor assembly. Disconnect all sensor wire connections at the J-Box.

---

**NOTE:** It is necessary to remove power to the J-Box while changing the DM-700 sensor in order to maintain area classification.

---

b) Use a wrench and the wrench flats provided at the top section of the ITM and unthread the ITM until it can be removed.

c) Use a 1/16" Allen wrench to release the locking setscrew that locks the ITM and Splash Guard Adapter together (One turn will suffice - Do not remove setscrew completely).

d) Remove splashguard. Unthread and remove the Splash Guard Adapter from the ITM.

e) Feed the new DM-700 sensor assembly wires through the 3/4" female NPT mounting hole and thread the assembly into the J-box until tight and the ITM lens faces toward the front access point. Connect the sensor assembly wires inside J-Box (Refer to Section 2.6, and Figure 10).

d) DM-700 sensors are factory calibrated, however, they require an initial AutoZero and AutoSpan calibration (Section 3.4), and must be configured per customer specific application requirements.

## 6. Troubleshooting Guide

Refer to the list of Failsafe Diagnostic features listed in Section 3.6.2 for additional reference in troubleshooting activities. Listed below are some typical trouble conditions and their probable cause and resolution path.

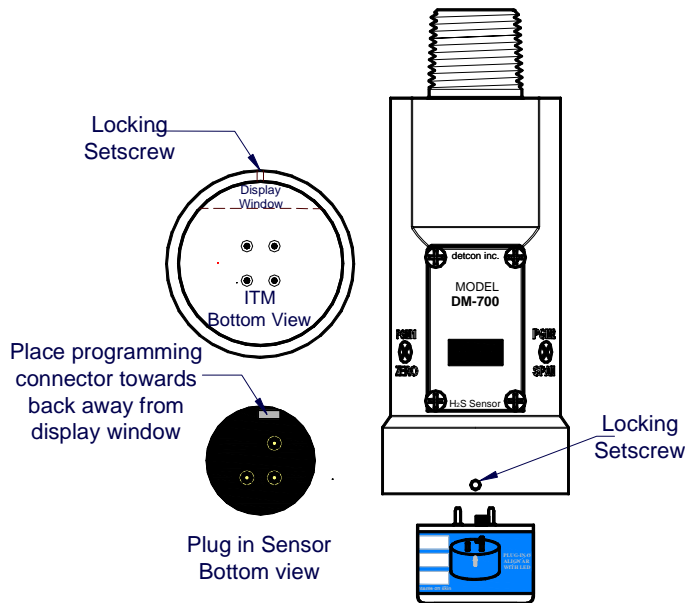

**Figure 16** Sensor Cell and ITM Mating

### Under-Range Fault

Probable Cause: Sensor Baseline drifted lower, Interference gasses.

- Repeat AutoZero. Use Zero Air or N<sub>2</sub> source.
- Allow more time for zero stabilization if this is a biased sensor type.
- Execute successful AutoSpan and verify adequate Sensor Life.
- Check Raw counts in View Sensor Status. Should be close to 33,000 counts when normal.
- Replace plug-in sensor if fault continues.

### Missing Sensor Fault

Probable Cause: Sensor is Missing, Failed Plug-in Sensor Electronics, or ITM I.S. Barrier Failure.

- Make sure plug-in sensor is plugged in properly with correct orientation.
- Swap plug-in sensor into another ITM to determine if plug-in sensor problem or ITM problem
- Replace the plug-in sensor if proven faulty
- Replace the ITM if proven faulty

### AutoSpan Calibration Faults – (Range, Stability and Clearing)

To clear any AutoSpan Calibration fault, the AutoSpan process must be completed successfully (Section3.4).

### Range Fault

Probable Causes: Failed Sensor, Cal Gas not applied or not applied at appropriate time, problems w/ cal gas and delivery.

- Check validity of span gas using pull tube or other means (check MFG date on cal gas cylinder).
- Use proper cal gas regulators and tubing for highly corrosive gasses
- If using Splashguard with Integral Cal Port, must use Calibration Wind Guard or air movement can compromise span gas delivery.
- Check for obstructions affecting cal gas hitting sensor face (including being wet, blocked, or corroded).
- Verify adequate Sensor Life
- Replace the plug-in toxic sensor.

### **Stability Fault**

Probable Causes: Failed Sensor, empty or close to empty Cal Gas Cylinder, problems w/ cal gas and delivery.

- Check validity of span gas using pull tube or other means (check MFG date on cal gas cylinder).
- Use proper cal gas regulators and tubing for highly corrosive gasses
- If using Splashguard with Integral Cal Port, must use Calibration Wind Guard or air movement can compromise span gas delivery.
- Check for obstructions affecting cal gas hitting sensor face (including being wet, blocked, or corroded).
- Verify adequate Sensor Life
- Replace the plug-in toxic sensor.

### **Clearing Fault**

Probable Causes: Failed Sensor, Cal Gas not removed at appropriate time, problems w/ cal gas and delivery, Background of Target Gas.

- Must recover to < 5% of range in < 5 min after AutoSpan is complete
- Use bottled air (zero air or N<sub>2</sub>) if there is a known continuous background level.
- Check validity of span gas using pull tube or other means (check MFG date on cal gas cylinder).
- Use proper cal gas regulators and tubing for highly corrosive gasses
- Check for obstructions affecting cal gas hitting sensor face (including being wet, blocked, or corroded).
- Verify adequate Sensor Life
- Replace the plug-in toxic sensor.

### **Poor Calibration Repeatability**

Probable Causes: Failed Sensor, use of wrong Cal Gas or problems w/ cal gas and delivery, Interference Gasses.

- Check for adequate Sensor Life.
- Check validity of span gas using pull tube or other means (check MFG date on cal gas cylinder).
- Use proper cal gas regulators and tubing for highly corrosive gasses
- Check for obstructions affecting cal gas hitting sensor face (including being wet, blocked, or corroded).
- Verify adequate Sensor Life
- Replace the plug-in toxic sensor.

### **Unstable Output/ Sudden spiking**

Possible Causes: Unstable power supply, inadequate grounding, or inadequate RFI protection.

- Verify Power source is stable.
- Verify field wiring is properly shielded and grounded.
- Contact Detcon to optimize shielding and grounding.
- Add Detcon's RFI Protection Circuit accessory if problem is proven RFI induced.

### Nuisance Alarms

Check conduit for accumulated water and abnormal corrosion on terminal blocks.

If nuisance alarms are happening at night, suspect condensation in conduit.

- Add or replace Detcon's Condensation Prevention Packet P/N 960-202200-000.
- Investigate the presence of other target gasses that are causing cross-interference signals.
- Determine if cause is RFI induced.

### Processor and/or Memory Faults

- Recycle power in attempt to clear problem
- Restore Factory Defaults - This will clear the processor's memory and may correct problem.
- Remember to re-enter all customer settings for range and cal gas level after Restore Factory Defaults.
- If problem persists, replace the Intelligent Transmitter Module.

### Unreadable Display

If due to excessive sunlight, install a sunshade to reduce glare.

### Nothing Displayed – Transmitter not Responding

- Verify conduit has no accumulated water or abnormal corrosion.
- Verify required DC power is applied to correct terminals.
- Swap with a known-good ITM to determine if ITM is faulty.

### Faulty 4-20 mA Output

If Sensor has a normal reading with no Faults displayed, and the 4-20 mA signal output is 0mA....

- Check that wiring is properly connected at terminal blocks and through to controller inputs.
- The 4-20 output loop must be closed (resistance of < 1000 ohms) to avoid the Loop Fault.
- Perform a "Signal Output Check" sequence via Section 3.5.5 and verify 4-20mA output with Current Meter.
- Swap with new ITM to determine if the ITM's 4-20mA output circuit is faulty. If the 4-20mA current loop is still out of tolerance, contact Detcon at [Service@detcon.com](mailto:Service@detcon.com), or contact Detcon customer service.

### No Communication - RS-485 Modbus™

If sensor has a normal reading with no Faults displayed and the Modbus™ is not communicating....

- Verify that the correct (and non-duplicated) serial address is entered (per Section 3.5.3).
- Check that the wiring is properly connected at terminal blocks, and the serial loop is wired correctly.
- Perform a "Signal Output Check" per Section 3.5.5 and troubleshoot wiring.
- Consider adding a Modbus™ repeater if the distance from the nearest distribution drop is excessive.
- Swap with new ITM to determine if the ITM's serial output circuit is faulty.
- Refer to Detcon's "Guide to Proper Modbus™ Communications" Application Note.

## 7. Customer Support and Service Policy

Detcon Headquarters

Shipping Address: 4055 Technology Forest Blvd., The Woodlands Texas 77381

Mailing Address: P.O. Box 8067, The Woodlands Texas 77387-8067

Phone: 888.367.4286, or 281.367.4100

Fax: 281.292.2860

- [www.detcon.com](http://www.detcon.com)
- [service@detcon.com](mailto:service@detcon.com)
- [sales@detcon.com](mailto:sales@detcon.com)

All Technical Service and Repair activities should be handled by the Detcon Service Department via phone, fax, or email at contact information given above. RMA numbers should be obtained from the Detcon Service Department prior to equipment being returned. For on-line technical service, customers should have ready the model number, part number, and serial number of product(s) in question.

All Sales activities (including spare parts purchase) should be handled by the Detcon Sales Department via phone, fax or email at contact information given above.

### 7.1 Warranty Notice

Detcon Inc. warrants the Model DM-700 toxic gas sensors to be free from defects in workmanship of material under normal use and service for two years from the date of shipment on the ITM electronics and for the conditional warranty period on the intelligent plug-in sensor type as listed in the Warranty column of Table 4 in Section 9.

Detcon Inc. will repair or replace without charge any such equipment found to be defective during the warranty period. Full determination of the nature of, and responsibility for, defective or damaged equipment will be made by Detcon Inc. personnel.

Defective or damaged equipment must be shipped to the Detcon Inc. factory or representative from which the original shipment was made. In all cases, this warranty is limited to the cost of the equipment supplied by Detcon Inc. The customer will assume all liability for the misuse of this equipment by its employees or other contracted personnel.

All warranties are contingent upon the proper use in the application for which the product was intended and does not cover products which have been modified or repaired without Detcon Inc. approval, or which have been subjected to neglect, accident, improper installation or application, or on which the original identification marks have been removed or altered.

Except for the express warranty stated above, Detcon Inc. disclaims all warranties with regard to the products sold. Including all implied warranties of merchantability and fitness and the express warranties stated herein are in lieu of all obligations or liabilities on the part of Detcon Inc. for damages including, but not limited to, consequential damages arising out of, or in connection with, the performance of the product.

## 8. DM-700 Sensor Warranty

### Intelligent Plug-in Sensor Warranty

Detcon Inc. warrants, under normal intended use, each new intelligent plug-in sensor per the period specified in the Warranty column of Table 4 (See Section 9) and under the conditions described as follows: The warranty period begins on the date of shipment to the original purchaser. The sensor element is warranted to be free of defects in material and workmanship. Should any sensor fail to perform in accordance with published specifications within the warranty period, return the defective part to Detcon, Inc., 4055 Technology Forest Blvd., The Woodlands, Texas 77381, for necessary repairs or replacement.

#### Terms & Conditions

- \* The original serial number must be legible on each sensor element base.
- \* Shipping point is FOB the Detcon factory.
- \* Net payment is due within 30 days of invoice.
- \* Detcon, Inc. reserves the right to refund the original purchase price in lieu of sensor replacement.

### ITM Electronics Warranty

Detcon Inc. warrants, under intended normal use, each new Model 700 ITM to be free from defects in material and workmanship for a period of two years from the date of shipment to the original purchaser. All warranties and service policies are FOB the Detcon facility located in The Woodlands, Texas.

#### Terms & Conditions

- \* The original serial number must be legible on each ITM.
- \* Shipping point is FOB the Detcon factory.
- \* Net payment is due within 30 days of invoice.
- \* Detcon, Inc. reserves the right to refund the original purchase price in lieu of ITM replacement.



# 9. Appendix

## 9.1 Specifications

### System Specifications

Sensor Type:	Continuous diffusion/adsorption type 3-Electrode Electrochemical Sensor (2-Electrode for O <sub>2</sub> ) Plug-in Replaceable Intelligent Type
Sensor Life:	2 years typical
Measuring Ranges:	0-1 ppm up to 0-10,000 ppm (Toxic Gasses) 0-100 ppm up to 0-25% volume (O <sub>2</sub> )
Accuracy/ Repeatability:	±10% of applied gas or +/- 2ppm, greater of (ISA 92.0.01 tested for H <sub>2</sub> S) ±2% of full-range (other Toxic Gasses) ±1% of full-range (O <sub>2</sub> )
Response Time:	T90 < 30 seconds typical (See Sensor Table)
Performance Testing:	Complies with ISA 92.0.01 Part 1-1998; Performance Requirements for H <sub>2</sub> S
Electrical Classification:	CSA and US (NRTL) Class I, Division 1, Groups A, B, C, D  ATEX Class I, Zone 1, Group IIC II 2 G Ex d [ib] ib IIC T4 Gb
Approvals:	cCSA <sub>US</sub> , ATEX, CE Marking
Warranty:	Electronics – 2 years Sensor – (See Table 4)

### Environmental Specifications

Operating Temperature:	-40°C to +50°C typical (See Table 4) (ISA 92.0.01 tested from -40°C to +50°C for H <sub>2</sub> S)
Storage Temperature:	-35°C to +55°C typical
Operating Humidity:	10-95% RH Continuous Duty (See Table 4) (ISA 92.0.01 tested to 5-95% RH for H <sub>2</sub> S) 0-100% RH Short-Term Duration Only
Operating Pressure:	Ambient ± 10%
Air Velocity:	0-5 meters/second

**Electrical Specifications**

Input Voltage:	11-30 VDC
Power Consumption:	Normal operation = 30mA (<0.75 watt); Maximum = 50mA (1.2 watts) Inrush Current = 1.67A @ 24V
RFI/EMI Protection:	Complies with EN61326
Analog Output:	Linear 4-20mA DC current 1000 ohms maximum loop load @ 24VDC 0 mA All Fault Diagnostics 2 mA In-Calibration 4-20 mA 0-100% full-scale 22 mA Over-range condition
Serial Output:	RS-485 Modbus™ RTU Baud Rate 9600 BPS (9600,N,8,1 Half Duplex)
Status Indicators:	4-digit LED Display with gas concentration, full-script menu prompts for AutoSpan, Set-up Options, and Fault Reporting
Faults Monitored:	Loop Fault, Input Voltage Fault, Missing Sensor Fault, Zero Fault, Processor Fault, Memory Fault, Calibration Fault(s)
Cable Requirements:	Power/Analog: 3-wire shielded cable Maximum distance is 13,300 feet with 14 AWG  Serial Output: 2-wire twisted-pair shielded cable specified for RS-485 use Maximum distance is 4,000 feet to last sensor

**Mechanical Specifications**

Length:	7.6 inches (190 mm), Includes Splashguard
Width:	2.2 inches (55 mm)
Weight:	2.5 lbs (1.2 Kg)
Mechanical Connection:	3/4" Male NPT threaded connection
Electrical Connection:	Five 18 gauge wire leads - 5.5" long

**Table 4 Sensor Specific Data**

Gas	GasName	Part Number <sup>1</sup>	Response Time (seconds)	SpanDrift	Temperature Range °C	Humidity Range%	Warranty
O <sub>2</sub>	Oxygen	377-343401-025	T95<30	<5%signal loss/year	-20 to+50	15 to 90	2 years
C <sub>2</sub> H <sub>3</sub> O	Acetaldehyde	377-12EA01-100	T90<140	<5%signal loss/year	-20 to+50	15 to 90	2 years
C <sub>2</sub> H <sub>2</sub>	Acetylene	377-12EG01-100	T90<140	<5%signal loss/year	-20 to+50	15 to 90	2 years
C <sub>3</sub> H <sub>3</sub> N	Acrylonitrile	377-12EM01-100	T90<140	<5%signal loss/year	-20 to+50	15 to 90	2 years
NH <sub>3</sub>	Ammonia	377-505001-100	T90<90	<2%signal loss/month	-40 to+50	15 to 90	2 years
AsH <sub>3</sub>	Arsine	377-191901-001	T90<60	<5%signal loss/month	-20 to+40	20 to 95	1.5 years
Br <sub>2</sub>	Bromine	377-747501-005	T90<60	<2%signal loss/month	-20 to+50	15 to 90	2 years
C <sub>4</sub> H <sub>6</sub>	Butadiene	377-12EB01-100	T90<140	<5%signal loss/year	-20 to+50	15 to 90	2 years
CO	Carbon Monoxide	377-444401-100	T90=30	<5%signal loss/year	-40 to+50	15 to 90	3 years
Cl <sub>2</sub>	Chlorine	377-747401-010	T90<60	<2%signal loss/month	-20 to+50	15 to 90	2 years
ClO <sub>2</sub> (>10ppm)	Chlorine Dioxide	377-777701-001	T90<60	<2%signal loss/month	-20 to+50	15 to 90	2 years
ClO <sub>2</sub> (<=10ppm)	Chlorine Dioxide	377-282801-050	T90<120	<1%signal loss/month	-20 to+40	10 to 95	2 years
B <sub>2</sub> H <sub>6</sub>	Diborane	377-192101-005	T90<60	<5%signal loss/month	-20 to+40	20 to 95	1.5 years
C <sub>2</sub> H <sub>5</sub> OH	Ethanol	377-12E001-100	T90<140	<5%signal loss/year	-20 to+50	15 to 90	2 years
C <sub>2</sub> H <sub>5</sub> SH	Ethyl Mercaptan	377-24EZ01-100	T90<45	<2%signal loss/month	-40 to+50	15 to 90	2 years
C <sub>2</sub> H <sub>4</sub>	Ethylene	377-12ED01-100	T90<140	<5%signal loss/year	-20 to+50	15 to 90	2 years
C <sub>2</sub> H <sub>4</sub> O	Ethylene Oxide	377-12EJ01-100	T90<140	<5%signal loss/year	-20 to+50	15 to 90	2 years
F <sub>2</sub>	Fluorine	377-272701-001	T90<80	<5%signal loss/year	-10 to+40	10 to 95	1.5 years
CH <sub>2</sub> O	Formaldehyde	377-12EP01-100	T90<140	<5%signal loss/year	-20 to+50	15 to 90	2 years
GeH <sub>4</sub>	Germane	377-232501-002	T90<60	<1%signal loss/month	-20 to+40	20 to 95	1.5 years
N <sub>2</sub> H <sub>4</sub>	Hydrazine	377-262601-001	T90<120	<5%signal loss/month	-10 to+40	10 to 95	1 year
H <sub>2</sub> (ppm)	Hydrogen	377-848401-100	T90=30	<2%signal loss/month	-20 to+50	15 to 90	2 years
H <sub>2</sub> (LEL)*	Hydrogen	377-050501-04P	T90<60	<2%signal loss/month	-40 to+40	5 to 95	2 years
HBr	Hydrogen Bromide	377-090801-030	T90<70	<3%signal loss/month	-20 to+40	10 to 95	1.5 years
HCl	Hydrogen Chloride	377-090901-030	T90<70	<2%signal loss/month	-20 to+40	10 to 95	1.5 years
HCN	Hydrogen Cyanide	377-131301-030	T90<40	<5%signal loss/month	-40 to+40	5 to 95	2 years
HF	Hydrogen Fluoride	377-333301-010	T90<90	<10%signal loss/month	-20 to+35	10 to 80	1.5 years
H <sub>2</sub> S	Hydrogen Sulfide	377-242401-100	T80<30	<2%signal loss/month	-40 to+50	15 to 90	2 years
CH <sub>3</sub> OH	Methanol	377-12EE01-100	T90<140	<5%signal loss/year	-20 to+50	15 to 90	2 years
CH <sub>3</sub> SH	Methyl Mercaptan	377-24EK01-100	T90<45	<2%signal loss/month	-40 to+50	15 to 90	2 years
NO	Nitric Oxide	377-949401-100	T90=10	<2%signal loss/month	-20 to+50	15 to 90	3 years
NO <sub>2</sub>	Nitrogen Dioxide	377-646401-010	T90<40	<2%signal loss/month	-20 to+50	15 to 90	2 years
O <sub>3</sub>	Ozone	377-999901-001	T90<120	<1%signal loss/month	-10 to+40	10 to 95	2 years
COCl <sub>2</sub>	Phosgene	377-414101-001	T90<120	<1%signal loss/month	-20 to+40	10 to 95	1.5 years
PH <sub>3</sub>	Phosphine	377-192001-005	T90<30	<1%signal loss/month	-20 to+40	20 to 95	1.5 years
SiH <sub>4</sub>	Silane	377-232301-050	T90<60	<1%signal loss/month	-20 to+40	20 to 95	1.5 years
SO <sub>2</sub>	Sulfur Dioxide	377-555501-020	T90=20	<2%signal loss/month	-20 to+50	15 to 90	2 years
C <sub>4</sub> H <sub>6</sub> O <sub>2</sub>	Vinyl Acetate	377-12EF01-100	T90<140	<5%signal loss/year	-20 to+50	15 to 90	2 years
C <sub>2</sub> H <sub>3</sub> Cl	Vinyl Chloride	377-12EL01-100	T90<140	<5%signal loss/year	-20 to+50	15 to 90	2 years

<sup>1</sup> The last three digits of the Part Number are the range of the sensor cell. I.E. "-100" is a 100ppm range.  
DM-700 Instruction Manual

## 9.2 Interference Table

Reference Table 5 to match the interfering gas symbol with the gas name. Then refer to Table 6. The Cross Interfering Gas Table extends for 5 pages, with each sensor specific gas repeated in each section of the table, for a column listing of 40 gasses. The list is followed by a row of 14 possible interfering gasses per page. Review each page for the applicable sensor gas and then scan across the row for possible interference gasses.

**Table 5 Interfering Gasses**

Acetaldehyde	C <sub>2</sub> H <sub>3</sub> O	Dimethyl Sulfide	C <sub>2</sub> H <sub>6</sub> S	Methane	CH <sub>4</sub>
Acetylene	C <sub>2</sub> H <sub>2</sub>	Disilane	Si <sub>2</sub> H <sub>6</sub>	Methanol	CH <sub>3</sub> OH
Acrylonitrile	C <sub>3</sub> H <sub>3</sub> N	Epichlorohydrin	C <sub>3</sub> H <sub>5</sub> OCl	Methyl-ethyl-ketone	C <sub>4</sub> H <sub>8</sub> O
Alcohols	Alcohols	Ethanol	C <sub>2</sub> H <sub>5</sub> OH	Methyl Mercaptan	CH <sub>3</sub> SH
Amines	Amines	Ethyl Mercaptan	C <sub>2</sub> H <sub>5</sub> SH	Nitric Oxide	NO
Ammonia	NH <sub>3</sub>	Ethylene	C <sub>2</sub> H <sub>4</sub>	Nitrogen	N <sub>2</sub>
Arsenic Trifluoride	AsF <sub>3</sub>	Ethylene Oxide	C <sub>2</sub> H <sub>4</sub> O	Nitrogen Dioxide	NO <sub>2</sub>
Arsenic Pentafluoride	AsF <sub>5</sub>	Fluorine	F <sub>2</sub>	Ozone	O <sub>3</sub>
Arsine	AsH <sub>3</sub>	Formaldehyde	CH <sub>2</sub> O	Phosgene	COCl <sub>2</sub>
Boron Trifluoride	BF <sub>3</sub>	Germane	GeH <sub>4</sub>	Phosphine	PH <sub>3</sub>
Bromine	Br <sub>2</sub>	Hydrazine	N <sub>2</sub> H <sub>4</sub>	Phosphorous Trifluoride	PF <sub>3</sub>
Butadiene	C <sub>4</sub> H <sub>6</sub>	Hydrocarbons	C-H's	Silane	SiH <sub>4</sub>
Buten-1	Buten-1	Hydrocarbons (unsaturated)	C-H's (μ)	Silicon	Si
Carbon Dioxide	CO <sub>2</sub>	Hydrogen	H <sub>2</sub>	Silicon Tetra Fluoride	SiF <sub>4</sub>
Carbon Disulfide	CS <sub>2</sub>	Hydrogen Bromide	HBr	Sulfur Dioxide	SO <sub>2</sub>
Carbon Oxide Sulfide	COS	Hydrogen Chloride	HCl	Tetrahydrothiophene	C <sub>4</sub> H <sub>8</sub> S
Carbon Monoxide	CO	Hydrogen Cyanide	HCN	Thiophane	C <sub>4</sub> H <sub>4</sub> S
Carbonyl Sulfide	CS	Hydrogen Fluoride	HF	Toluene	C <sub>6</sub> H <sub>5</sub> CH <sub>3</sub>
Chlorine	Cl <sub>2</sub>	Hydrogen Selenide	HSe	Tungsten Hexafluoride	WF <sub>6</sub>
Chlorine Dioxide	ClO <sub>2</sub>	Hydrogen Sulfide	H <sub>2</sub> S	Vinyl Acetate	C <sub>4</sub> H <sub>6</sub> O <sub>2</sub>
Chlorine Trifluoride	ClF <sub>3</sub>	Dimethyl Sulfide	C <sub>2</sub> H <sub>6</sub> S	Vinyl Chloride	C <sub>2</sub> H <sub>3</sub> Cl
Diborane	B <sub>2</sub> H <sub>6</sub>	Disilane	Si <sub>2</sub> H <sub>7</sub>		

**Table 6 Cross Interference Table pg.1**

Gas	C <sub>2</sub> H <sub>3</sub> O	C <sub>2</sub> H <sub>2</sub>	C <sub>3</sub> H <sub>3</sub> N	Alcohols	Amines	NH <sub>3</sub>	AsF <sub>3</sub>	AsF <sub>5</sub>	AsH <sub>3</sub>	BF <sub>3</sub>	Br <sub>2</sub>	C <sub>4</sub> H <sub>6</sub>	Buten-1
C <sub>2</sub> H <sub>3</sub> O	n/a	40=340	40=75	n/d	n/d	n/d	n/d	n/d	n/d	n/d	n/d	40=170	n/d
C <sub>2</sub> H <sub>2</sub>	340=40	n/a	340=75	n/d	n/d	n/d	n/d	n/d	n/d	n/d	n/d	340=170	n/d
C <sub>3</sub> H <sub>3</sub> N	75=40	75=340	n/a	n/d	n/d	n/d	n/d	n/d	n/d	n/d	n/d	75=170	n/d
NH <sub>3</sub>	n/d	n/d	n/d	n/d	n/d	n/d	n/d	n/d	n/d	n/d	n/d	n/d	n/d
AsH <sub>3</sub>	n/d	n/d	n/d	n/d	n/d	100=0.01	n/d	n/d	n/a	n/d	n/d	n/d	n/d
Br <sub>2</sub>	n/d	n/d	n/d	n/d	n/d	n/d	n/d	n/d	n/d	n/d	n/a	n/d	n/d
C <sub>4</sub> H <sub>6</sub>	170=40	170=340	170=75	n/d	n/d	n/d	n/d	n/d	n/d	n/d	n/d	n/a	n/d
CS <sub>2</sub>	140=40	140=340	140=75	n/d	n/d	n/d	n/d	n/d	n/d	n/d	n/d	140=170	n/d
CO	n/d	n/d	n/d	n/d	n/d	n/d	n/d	n/d	n/d	n/d	n/d	n/d	n/d
Cl <sub>2</sub>	n/d	n/d	n/d	n/d	n/d	n/d	n/d	n/d	n/d	n/d	1=0.55	n/d	n/d
ClO <sub>2</sub> (>10ppm)	n/d	n/d	n/d	n/d	n/d	n/d	n/d	n/d	n/d	n/d	1=0.18	n/d	n/d
ClO <sub>2</sub> (=10ppm)	n/d	n/d	n/d	n/d	n/d	n/d	n/d	n/d	n/d	n/d	n/d	n/d	n/d
B <sub>2</sub> H <sub>6</sub>	n/d	n/d	n/d	n/d	n/d	100=0.013	n/d	n/d	0.15=0.2	n/d	n/d	n/d	n/d
C <sub>3</sub> H <sub>5</sub> OC1	50=40	50=340	50=75	n/d	n/d	n/d	n/d	n/d	n/d	n/d	n/d	50=170	n/d
C <sub>2</sub> H <sub>5</sub> OH	180=40	180=340	180=75	n/d	n/d	n/d	n/d	n/d	n/d	n/d	n/d	180=170	n/d
C <sub>2</sub> H <sub>5</sub> SH	n/d	n/d	n/d	n/d	n/d	n/d	n/d	n/d	n/d	n/d	n/d	n/d	n/d
C <sub>2</sub> H <sub>4</sub>	220=40	220=340	220=75	n/d	n/d	n/d	n/d	n/d	n/d	n/d	n/d	220=170	n/d
C <sub>2</sub> H <sub>4</sub> O	275=40	275=340	275=75	n/d	n/d	n/d	n/d	n/d	n/d	n/d	n/d	275=170	n/d
F <sub>2</sub>	n/d	n/d	n/d	1000=0	n/d	n/d	n/d	n/d	0.1=0	n/d	yes n/d	n/d	n/d
CH <sub>2</sub> O	330=40	330=340	330=75	n/d	n/d	n/d	n/d	n/d	n/d	n/d	n/d	330=170	n/d
GeH <sub>4</sub>	n/d	n/d	n/d	n/d	n/d	100=<1	n/d	n/d	0.2=0.14	n/d	n/d	n/d	n/d
N <sub>2</sub> H <sub>4</sub>	n/d	n/d	n/d	1000=0	n/d	200=0.04	n/d	n/d	0.1=0.1	n/d	n/d	n/d	n/d
H <sub>2</sub> (ppm)	n/d	n/d	n/d	n/d	n/d	n/d	n/d	n/d	n/d	n/d	n/d	n/d	n/d
H <sub>2</sub> (LEL)	n/d	n/d	n/d	n/d	n/d	100=0	n/d	n/d	n/d	n/d	n/d	n/d	n/d
HBr	n/d	n/d	n/d	1000=0	no	n/d	n/d	n/d	0.1=0.3	n/d	n/d	n/d	n/d
HCl	n/d	n/d	n/d	1000=0	no	n/d	n/d	n/d	0.1=0.3	n/d	n/d	n/d	n/d
HCN	n/d	n/d	n/d	1000=0	n/d	n/d	n/d	n/d	0.1=0	n/d	yes n/d	n/d	n/d
HF	n/d	n/d	n/d	1000=0	n/d	n/d	yes n/d	yes n/d	0.1=0	yes n/d	n/d	n/d	n/d
H <sub>2</sub> S	n/d	n/d	n/d	n/d	n/d	n/d	n/d	n/d	n/d	n/d	n/d	n/d	n/d
CH <sub>3</sub> OH	415=40	415=340	415=75	n/d	n/d	n/d	n/d	n/d	n/d	n/d	n/d	415=170	n/d
CH <sub>3</sub> SH	n/d	n/d	n/d	n/d	n/d	n/d	n/d	n/d	n/d	n/d	n/d	275=170	n/d
NO	n/d	n/d	n/d	n/d	n/d	n/d	n/d	n/d	n/d	n/d	n/d	n/d	n/d
NO <sub>2</sub>	n/d	n/d	n/d	n/d	n/d	n/d	n/d	n/d	n/d	n/d	n/d	n/d	n/d
O <sub>3</sub>	n/d	n/d	n/d	n/d	n/d	n/d	n/d	n/d	0.1=0.05	n/d	yes n/d	n/d	n/d
COCl <sub>2</sub>	n/d	n/d	n/d	1000=0	n/d	50=0.5	n/d	n/d	n/d	n/d	n/d	n/d	n/d
PH <sub>3</sub>	n/d	n/d	n/d	n/d	n/d	100=0.01	n/d	n/d	1=1	n/d	n/d	n/d	n/d
SiH <sub>4</sub>	n/d	n/d	n/d	n/d	n/d	100=<1	n/d	n/d	0.2=0.14	n/d	n/d	n/d	n/d
SO <sub>2</sub>	n/d	n/d	n/d	n/d	n/d	n/d	n/d	n/d	n/d	n/d	n/d	n/d	n/d
C <sub>4</sub> H <sub>6</sub> O <sub>2</sub>	200=40	200=340	200=75	n/d	n/d	n/d	n/d	n/d	n/d	n/d	n/d	200=170	n/d
C <sub>2</sub> H <sub>3</sub> Cl	200=40	200=340	200=75	n/d	n/d	n/d	n/d	n/d	n/d	n/d	n/d	200=170	n/d

n/a – not applicable

n/d – no data

**Table 6 Cross Interference Gasses pg.2**

Gas	CO <sub>2</sub>	CS <sub>2</sub>	CO	COS	CL <sub>2</sub>	CLO <sub>2</sub>	CLF <sub>3</sub>	B <sub>2</sub> H <sub>6</sub>	C <sub>2</sub> H <sub>6</sub> S	Si <sub>2</sub> H <sub>6</sub>	C <sub>3</sub> H <sub>5</sub> OCL	C <sub>2</sub> H <sub>5</sub> OH	F <sub>2</sub>
C <sub>2</sub> H <sub>3</sub> O	n/d	40=140	40=100	40=135	n/d	n/d	n/d	n/d	40=150	n/d	40=50	40=180	n/d
C <sub>2</sub> H <sub>2</sub>	n/d	340=140	340=100	340=135	n/d	n/d	n/d	n/d	340=150	n/d	340=50	340=180	n/d
C <sub>3</sub> H <sub>3</sub> N	n/d	75=140	75=100	75=135	n/d	n/d	n/d	n/d	75=150	n/d	75=50	75=180	n/d
NH <sub>3</sub>	n/d	n/d	300=8	n/d	1=-1	10%=-15	n/d	n/d	n/d	n/d	n/d	n/d	n/d
AsH <sub>3</sub>	5000=0	n/d	300=0	n/d	0.5=-0.04	n/d	n/d	0.2=0.15	n/d	5=yes n/d	n/d	n/d	n/d
Br <sub>2</sub>	n/d	n/d	300=0	n/d	1=2	1=6	n/d	n/d	n/d	n/d	n/d	n/d	n/d
C <sub>4</sub> H <sub>6</sub>	n/d	170=140	170=100	170=135	n/d	n/d	n/d	n/d	170=150	n/d	170=50	170=180	n/d
CS <sub>2</sub>	n/d	n/a	140=100	140=135	n/d	n/d	n/d	n/d	140=150	n/d	140=50	140=180	n/d
CO	n/d	n/d	n/a	n/d	1=0	n/d	n/d	n/d	n/d	n/d	n/d	200=0	n/d
Cl <sub>2</sub>	n/d	n/d	300=0	n/d	n/a	n/d	n/d	n/d	n/d	n/d	n/d	n/d	n/d
ClO <sub>2</sub> (>10ppm)	n/d	n/d	300=0	n/d	3=1	n/a	n/d	n/d	n/d	n/d	n/d	n/d	n/d
ClO <sub>2</sub> (=10ppm)	5000=0	n/d	1000=0	n/d	1=0.9	n/a	yes n/d	0.1=0	n/d	n/d	n/d	n/d	yes n/d
B <sub>2</sub> H <sub>6</sub>	5000=0	n/d	300=0	n/d	0.5=-0.05	n/d	n/d	n/a	n/d	5=yes n/d	n/d	n/d	n/d
C <sub>3</sub> H <sub>5</sub> OCl	n/d	50=140	50=100	50=135	n/d	n/d	n/d	n/d	50=150	n/d	n/a	50=180	n/d
C <sub>2</sub> H <sub>5</sub> OH	n/d	180=140	180=100	180=135	n/d	n/d	n/d	n/d	180=150	n/d	180=50	n/a	n/d
C <sub>2</sub> H <sub>5</sub> SH	n/d	n/d	300=5	n/d	1=-0.6	n/d	n/d	n/d	n/d	n/d	n/d	n/d	n/d
C <sub>2</sub> H <sub>4</sub>	n/d	220=140	220=100	220=135	n/d	n/d	n/d	n/d	220=150	n/d	220=50	220=180	n/d
C <sub>2</sub> H <sub>4</sub> O	n/d	275=140	275=100	275=135	n/d	n/d	n/d	n/d	275=150	n/d	275=50	275=180	n/d
F <sub>2</sub>	5000=0	n/d	1000=0	n/d	1=1.3	n/d	n/d	n/d	n/d	n/d	n/d	n/d	n/a
CH <sub>2</sub> O	n/d	330=140	330=100	330=135	n/d	n/d	n/d	n/d	330=150	n/d	330=50	330=180	n/d
GeH <sub>4</sub>	5000=0	n/d	300=0	n/d	0.5=-0.04	n/d	n/d	0.2=0.11	n/d	5=yes n/d	n/d	n/d	n/d
N <sub>2</sub> H <sub>4</sub>	5000=0	n/d	1000=0	n/d	1=0	n/d	n/d	n/d	n/d	n/d	n/d	n/d	n/d
H <sub>2</sub> (ppm)	n/d	n/d	300=<30	n/d	1=0	n/d	n/d	n/d	n/d	n/d	n/d	n/d	n/d
H <sub>2</sub> (LEL)	1000=0	n/d	50=6	n/d	5=0	n/d	n/d	n/d	n/d	n/d	n/d	n/d	n/d
HBr	5000=0	n/d	1000=0	n/d	5=1	n/d	yes n/d	n/d	n/d	n/d	n/d	n/d	n/d
HCl	5000=0	n/d	1000=0	n/d	5=1	n/d	1=yes n/d	n/d	n/d	n/d	n/d	n/d	n/d
HCN	5000=0	n/d	1000=0	n/d	5=-1	n/d	n/d	n/d	n/d	n/d	n/d	n/d	n/d
HF	5000=0	n/d	1000=0	n/d	1=0.4	n/d	yes n/d	0.1=0	n/d	n/d	n/d	n/d	yes n/d
H <sub>2</sub> S	n/d	n/d	300=1.5	n/d	1=-0.2	n/d	n/d	n/d	n/d	n/d	n/d	n/d	n/d
CH <sub>3</sub> OH	n/d	415=140	415=100	415=135	n/d	n/d	n/d	n/d	415=150	n/d	415=50	415=180	n/d
CH <sub>3</sub> SH	n/d	n/d	300=3	n/d	1=-0.4	n/d	n/d	n/d	n/d	n/d	n/d	n/d	n/d
NO	n/d	n/d	300=0	n/d	1=0	n/d	n/d	n/d	n/d	n/d	n/d	n/d	n/d
NO <sub>2</sub>	n/d	n/d	300=0	n/d	1=-1	n/d	n/d	n/d	n/d	n/d	n/d	n/d	n/d
O <sub>3</sub>	5000=0	n/d	300=0	n/d	1=1.4	0.1=0.12	1=1(theory)	n/d	n/d	n/d	n/d	n/d	0.1=0.07
COCl <sub>2</sub>	5000=0	n/d	1000=0	n/d	1=0	n/d	n/d	n/d	n/d	n/d	n/d	n/d	n/d
PH <sub>3</sub>	5000=0	n/d	300=0	n/d	0.5=-0.04	n/d	n/d	0.2=0.15	n/d	5=yes n/d	n/d	n/d	n/d
SiH <sub>4</sub>	5000=0	n/d	300=0	n/d	0.5=-0.04	n/d	n/d	0.2=0.11	n/d	5=yes n/d	n/d	n/d	n/d
SO <sub>2</sub>	n/d	n/d	300=<5	n/d	1=<0.5	n/d	n/d	n/d	n/d	n/d	n/d	n/d	n/d
C <sub>4</sub> H <sub>6</sub> O <sub>2</sub>	n/d	200=140	200=100	200=135	n/d	n/d	n/d	n/d	200=150	n/d	200=50	200=180	n/d
C <sub>2</sub> H <sub>3</sub> Cl	n/d	200=140	200=100	200=135	n/d	n/d	n/d	n/d	200=150	n/d	200=50	200=180	n/d

n/a – not applicable

n/d – no data

**Table 6 Cross Interference Gasses pg.3**

Gas	C <sub>2</sub> H <sub>4</sub>	C <sub>2</sub> H <sub>4</sub> O	CH <sub>2</sub> O	GeH <sub>4</sub>	N <sub>2</sub> H <sub>4</sub>	C-H's	C-H's (U)	H <sub>2</sub>	HBr	HCL	HCN	HF	I <sub>2</sub>
C <sub>2</sub> H <sub>3</sub> O	40=220	40=275	40=330	N/d	n/d	n/d	n/d	n/d	n/d	n/d	n/d	n/d	n/d
C <sub>2</sub> H <sub>2</sub>	340=220	340=275	340=330	N/d	n/d	n/d	n/d	n/d	n/d	n/d	n/d	n/d	n/d
C <sub>3</sub> H <sub>3</sub> N	75=220	75=275	75=330	N/d	n/d	n/d	n/d	n/d	n/d	n/d	n/d	n/d	n/d
NH <sub>3</sub>	100=0	n/d	n/d	N/d	n/d	n/d	n/d	200=4	n/d	5=-3	10=0	n/d	n/d
AsH <sub>3</sub>	n/d	n/d	n/d	1=0.4	n/d	%range=0	n/d	3000=0	n/d	5=0	10=0.1	4=0	n/d
Br <sub>2</sub>	100=0	n/d	n/d	N/d	n/d	n/d	n/d	100=0	n/d	5=0	10=0	n/d	n/d
C <sub>4</sub> H <sub>6</sub>	170=220	170=275	170=330	N/d	n/d	n/d	n/d	n/d	n/d	n/d	n/d	n/d	n/d
CS <sub>2</sub>	140=220	140=275	140=330	N/d	n/d	n/d	n/d	n/d	n/d	n/d	n/d	n/d	n/d
CO	100=<100	n/d	n/d	N/d	n/d	n/d	n/d	100=<60	n/d	5=0	10=<2	n/d	n/d
Cl <sub>2</sub>	100=0	n/d	n/d	N/d	n/d	n/d	n/d	100=0	n/d	5=0	10=0	n/d	n/d
ClO <sub>2</sub> (>10ppm)	100=0	n/d	n/d	N/d	n/d	n/d	n/d	100=0	n/d	5=0	10=0	n/d	n/d
ClO <sub>2</sub> (=10ppm)	n/d	n/d	n/d	1=0	n/d	%range=0	n/d	1%=0	n/d	n/d	n/d	n/d	n/d
B <sub>2</sub> H <sub>6</sub>	n/d	n/d	n/d	1=0.53	n/d	%range=0	n/d	3000=0	n/d	5=0	10=0.13	4=0	n/d
C <sub>3</sub> H <sub>5</sub> OCl	50=220	50=275	50=330	N/d	n/d	n/d	n/d	n/d	n/d	n/d	n/d	n/d	n/d
C <sub>2</sub> H <sub>5</sub> OH	180=220	180=275	180=330	N/d	n/d	n/d	n/d	n/d	n/d	n/d	n/d	n/d	n/d
C <sub>2</sub> H <sub>5</sub> SH	100=0	n/d	n/d	N/d	n/d	n/d	n/d	1%=<15	n/d	5=0	10=0	n/d	n/d
C <sub>2</sub> H <sub>4</sub>	n/a	220=275	220=330	n/d	n/d	n/d	n/d	n/d	n/d	n/d	n/d	n/d	n/d
C <sub>2</sub> H <sub>4</sub> O	275=220	n/a	275=330	n/d	n/d	n/d	n/d	n/d	n/d	n/d	n/d	n/d	n/d
F <sub>2</sub>	n/d	n/d	n/d	n/d	n/d	%range=0	n/d	1%=0	n/d	5=0	1=-3	3=0	n/d
CH <sub>2</sub> O	330=220	330=275	n/a	n/d	n/d	n/d	n/d	n/d	n/d	n/d	n/d	n/d	n/d
GeH <sub>4</sub>	n/d	n/d	n/d	n/a	n/d	%range=0	n/d	3000=0	n/d	5=0	10=1	4=0	n/d
N <sub>2</sub> H <sub>4</sub>	n/d	n/d	n/d	n/d	n/a	%range=0	n/d	1000=0	n/d	5=0.1	n/d	3=0	n/d
H <sub>2</sub> (ppm)	100=ˆ80	n/d	n/d	n/d	n/d	n/d	n/d	n/a	n/d	5=0	10=ˆ3	n/d	n/d
H <sub>2</sub> (LEL)	yes n/d	n/d	n/d	n/d	n/d	n/d	n/d	n/a	n/d	n/d	10=0	n/d	n/d
HBr	n/d	n/d	n/d	n/d	n/d	%range=0	n/d	1%=0	n/a	1=1	15=1	3=0	n/d
HCl	n/d	n/d	n/d	1=n/d	n/d	%range=0	n/d	1%=0	1=1	n/a	15=1	3=0	n/d
HCN	n/d	n/d	n/d	n/d	n/d	%range=0	n/d	1000=0	n/d	5=0	n/a	3=0	n/d
HF	n/d	n/d	n/d	1=0	n/d	%range=0	n/d	1%=0	n/d	5=3.3	n/d	n/a	n/d
H <sub>2</sub> S	100=0	n/d	n/d	n/d	n/d	n/d	n/d	1%=<5	n/d	5=0	10=0	n/d	n/d
CH <sub>3</sub> OH	415=220	415=275	415=330	n/d	n/d	n/d	n/d	n/d	n/d	n/d	n/d	n/d	n/d
CH <sub>3</sub> SH	100=0	n/d	n/d	n/d	n/d	n/d	n/d	1%=<10	n/d	5=0	10=0	n/d	n/d
NO	100=0	n/d	n/d	n/d	n/d	n/d	n/d	100=0	n/d	5=<1	10=0	n/d	n/d
NO <sub>2</sub>	100=0	n/d	n/d	n/d	n/d	n/d	n/d	100=0	n/d	5=0	10=0	n/d	n/d
O <sub>3</sub>	n/d	n/d	n/d	n/d	n/d	n/d	n/d	1%=0.003	n/d	10=0	10=0.03	5=0	yes n/d
COCl <sub>2</sub>	n/d	n/d	n/d	n/d	n/d	%range=0	n/d	1%=0	n/d	5=0	5=0	3=0	n/d
PH <sub>3</sub>	n/d	n/d	n/d	1=0.4	n/d	%range=0	n/d	3000=0	n/d	5=0	10=0.1	4=0	n/d
SiH <sub>4</sub>	n/d	n/d	n/d	1=1.0	n/d	%range=0	n/d	3000=0	n/d	5=0	10=1	4=0	n/d
SO <sub>2</sub>	100=0	n/d	n/d	n/d	n/d	n/d	n/d	100=0	n/d	5=0	10=<5	n/d	n/d
C <sub>4</sub> H <sub>6</sub> O <sub>2</sub>	200=220	200=275	200=330	n/d	n/d	n/d	n/d	n/d	n/d	n/d	n/d	n/d	n/d
C <sub>2</sub> H <sub>3</sub> Cl	200=220	200=275	200=330	n/d	n/d	n/d	n/d	n/d	n/d	n/d	n/d	n/d	n/d

n/a – not applicable

n/d – no data

**Table 6 Cross Interference Gasses pg.4**

Gas	HSe	H <sub>2</sub> S	C <sub>3</sub> H <sub>8</sub> O	CH <sub>4</sub>	CH <sub>3</sub> OH	C <sub>4</sub> H <sub>8</sub> O	CH <sub>3</sub> SH	NO	N <sub>2</sub>	NO <sub>2</sub>	O <sub>3</sub>	COCl <sub>2</sub>	PH <sub>3</sub>
C <sub>2</sub> H <sub>3</sub> O	n/d	n/d	n/d	n/d	40=415	n/d	40=275	n/d	n/d	n/d	n/d	n/d	n/d
C <sub>2</sub> H <sub>2</sub>	n/d	n/d	n/d	n/d	340=415	n/d	340=275	n/d	n/d	n/d	n/d	n/d	n/d
C <sub>3</sub> H <sub>3</sub> N	n/d	n/d	n/d	n/d	75=415	n/d	75=275	n/d	n/d	n/d	n/d	n/d	n/d
NH <sub>3</sub>	n/d	15=30	n/d	n/d	n/d	n/d	n/d	35=6	n/d	5=-1	n/d	n/d	n/d
AsH <sub>3</sub>	0.05=0.005	1=0	n/d	n/d	n/d	n/d	n/d	n/d	100%=0	n/d	n/d	n/d	0.1=0.11
Br <sub>2</sub>	n/d	15=-1.5	n/d	n/d	n/d	n/d	n/d	35=0	n/d	5=-10	n/d	n/d	n/d
C <sub>4</sub> H <sub>6</sub>	n/d	n/d	n/d	n/d	170=415	n/d	170=275	n/d	n/d	n/d	n/d	n/d	n/d
CS <sub>2</sub>	n/d	n/d	n/d	n/d	140=415	n/d	140=275	n/d	n/d	n/d	n/d	n/d	n/d
CO	n/d	15=<0.3	n/d	n/d	n/d	n/d	n/d	35==7	n/d	5=0.5	n/d	n/d	n/d
Cl <sub>2</sub>	n/d	15=-0.75	n/d	n/d	n/d	n/d	n/d	35=0	n/d	5=-5	n/d	n/d	n/d
ClO <sub>2</sub> (>10ppm)	n/d	15=0.25	n/d	n/d	n/d	n/d	n/d	35=0	n/d	5=1.66	n/d	n/d	n/d
ClO <sub>2</sub> (=10ppm)	n/d	10=-0.015	n/d	n/d	n/d	n/d	n/d	n/d	n/d	yes n/d	yes n/d	n/d	n/d
B <sub>2</sub> H <sub>6</sub>	0.05=0.006	1=0	n/d	n/d	n/d	n/d	n/d	n/d	100%=0	n/d	n/d	n/d	0.1=0.14
C <sub>3</sub> H <sub>5</sub> OCl	n/d	n/d	n/d	n/d	50=415	n/d	50=275	n/d	n/d	n/d	n/d	n/d	n/d
C <sub>2</sub> H <sub>5</sub> OH	n/d	n/d	n/d	n/d	180=415	n/d	180=275	n/d	n/d	n/d	n/d	n/d	n/d
C <sub>2</sub> H <sub>5</sub> SH	n/d	1:03	n/d	n/d	n/d	n/d	5=8	35=<6	n/d	5=-1.5	n/d	n/d	n/d
C <sub>2</sub> H <sub>4</sub>	n/d	n/d	n/d	n/d	220=415	n/d	220=275	n/d	n/d	n/d	n/d	n/d	n/d
C <sub>2</sub> H <sub>4</sub> O	n/d	n/d	n/d	n/d	275=415	n/d	275=275	n/d	n/d	n/d	n/d	n/d	n/d
F <sub>2</sub>	n/d	1=-1.5	n/d	n/d	n/d	n/d	n/d	n/d	100%=0	1=0.05	0.1=0.2	n/d	n/d
CH <sub>2</sub> O	n/d	n/d	n/d	n/d	330=415	n/d	330=275	n/d	n/d	n/d	n/d	n/d	n/d
GeH <sub>4</sub>	0.05=0.005	1=0	n/d	n/d	n/d	n/d	n/d	n/d	100%=0	n/d	n/d	n/d	0.1=0.13
N <sub>2</sub> H <sub>4</sub>	n/d	1=0.1	n/d	n/d	n/d	n/d	n/d	n/d	100%=0	1=-0.25	0.1=-0.1	n/d	0.3=0.1
H <sub>2</sub> (ppm)	n/d	15=<3	n/d	n/d	n/d	n/d	n/d	35=-10	n/d	5=0	n/d	n/d	n/d
H <sub>2</sub> (LEL)	n/d	n/d	yes n/d	1%=0	n/d	n/d	n/d	yes n/d	n/d	10=0	n/d	n/d	n/d
HBr	0.1=0	10=2.75	n/d	n/d	n/d	n/d	n/d	n/d	100%=0	n/d	n/d	0.1=0	0.1=0.3
HCl	0.1=0	10=2.75	n/d	n/d	n/d	n/d	n/d	n/d	100%=0	n/d	n/d	0.1=0	0.1=0.3
HCN	n/d	10=0	n/d	n/d	n/d	n/d	n/d	n/d	100%=0	10=-12	0.1=0	n/d	0.3=0
HF	n/d	10=0	n/d	n/d	n/d	n/d	n/d	n/d	100%=0	10=0.1	n/d	n/d	0.1=0
H <sub>2</sub> S	n/d	n/a	n/d	n/d	n/d	n/d	2:01	35=<2	n/d	5=-0.5	n/d	n/d	n/d
CH <sub>3</sub> OH	n/d	n/d	n/d	n/d	n/a	n/d	415=275	n/d	n/d	n/d	n/d	n/d	n/d
CH <sub>3</sub> SH	n/d	1:02	n/d	n/d	n/d	n/d	n/a	35=<4	n/d	5=-1.0	n/d	n/d	n/d
NO	n/d	15=-5	n/d	n/d	n/d	n/d	n/d	100=0	n/d	5=<1.5	n/d	n/d	n/d
NO <sub>2</sub>	n/d	15=-0.75	n/d	n/d	n/d	n/d	n/d	35=0	n/d	n/a	n/d	n/d	n/d
O <sub>3</sub>	n/d	1=-.015	n/d	n/d	n/d	n/d	n/d	10=0	100%=0	1=0.7	n/a	n/d	0.3=0.03
COCl <sub>2</sub>	n/d	1=0	n/d	n/d	n/d	n/d	n/d	n/d	100%=0	n/d	n/d	n/a	0.3=0
PH <sub>3</sub>	0.05=0.005	1=0	n/d	n/d	n/d	n/d	n/d	n/d	100%=0	n/d	n/d	n/d	n/a
SiH <sub>4</sub>	0.05=0.005	1=0	n/d	n/d	n/d	n/d	n/d	n/d	100%=0	n/d	n/d	n/d	0.1=0.13
SO <sub>2</sub>	n/d	15=0	n/d	n/d	n/d	n/d	n/d	35=0	n/d	5=-5	n/d	n/d	n/d
C <sub>4</sub> H <sub>6</sub> O <sub>2</sub>	n/d	n/d	n/d	n/d	200=415	n/d	200=275	n/d	n/d	n/d	n/d	n/d	n/d
C <sub>2</sub> H <sub>3</sub> Cl	n/d	n/d	n/d	n/d	200=415	n/d	200=275	n/d	n/d	n/d	n/d	n/d	n/d

n/a – not applicable

n/d – no data



**Table 6 Cross Interference Gasses pg.5**

Gas	PF <sub>3</sub>	SiH <sub>4</sub>	Si	SiF <sub>4</sub>	SO <sub>2</sub>	C <sub>4</sub> H <sub>8</sub> S	C <sub>4</sub> H <sub>4</sub> S	C <sub>6</sub> H <sub>5</sub> CH <sub>3</sub>	WF <sub>6</sub>	C <sub>4</sub> H <sub>6</sub> O <sub>2</sub>	C <sub>2</sub> H <sub>3</sub> CL	C <sub>2</sub> H <sub>5</sub> SH	C <sub>6</sub> H <sub>5</sub> CH <sub>3</sub>
C <sub>2</sub> H <sub>3</sub> O	n/d	n/d	n/d	n/d	n/d	n/d	40=45	n/d	n/d	40=200	40=200	n/d	40=55
C <sub>2</sub> H <sub>2</sub>	n/d	n/d	n/d	n/d	n/d	n/d	340=45	n/d	n/d	340=200	340=200	n/d	340=55
C <sub>3</sub> H <sub>3</sub> N	n/d	n/d	n/d	n/d	n/d	n/d	75=45	n/d	n/d	75=200	75=200	n/d	75=55
NH <sub>3</sub>	n/d	n/d	n/d	n/d	5=-0.5	n/d	n/d	n/d	n/d	n/d	n/d	n/d	n/d
AsH <sub>3</sub>	n/d	1=0.56	n/d	n/d	2=0	n/d	n/d	n/d	n/d	n/d	n/d	n/d	n/d
Br <sub>2</sub>	n/d	n/d	n/d	n/d	5=-0.1	n/d	n/d	n/d	n/d	n/d	n/d	n/d	n/d
C <sub>4</sub> H <sub>6</sub>	n/d	n/d	n/d	n/d	n/d	n/d	170=45	n/d	n/d	170=200	170=200	n/d	170=55
CS <sub>2</sub>	n/d	n/d	n/d	n/d	n/d	n/d	140=45	n/d	n/d	140=200	140=200	n/d	140=55
CO	n/d	n/d	n/d	n/d	5=0	n/d	n/d	n/d	n/d	n/d	n/d	n/d	n/d
Cl <sub>2</sub>	n/d	n/d	n/d	n/d	5=-0.05	n/d	n/d	n/d	n/d	n/d	n/d	n/d	n/d
ClO <sub>2</sub> (>10ppm)	n/d	n/d	n/d	n/d	5=-0.016	n/d	n/d	n/d	n/d	n/d	n/d	n/d	n/d
ClO <sub>2</sub> (=10ppm)	n/d	n/d	n/d	n/d	n/d	n/d	n/d	n/d	n/d	n/d	n/d	n/d	n/d
B <sub>2</sub> H <sub>6</sub>	n/d	1=0.72	n/d	n/d	2=0	n/d	n/d	n/d	n/d	n/d	n/d	n/d	n/d
C <sub>3</sub> H <sub>5</sub> OCl	n/d	n/d	n/d	n/d	n/d	n/d	50=45	n/d	n/d	50=200	50=200	n/d	50=55
C <sub>2</sub> H <sub>5</sub> OH	n/d	n/d	n/d	n/d	n/d	n/d	180=45	n/d	n/d	180=200	180=200	n/d	180=55
C <sub>2</sub> H <sub>5</sub> SH	n/d	n/d	n/d	n/d	5=<3	n/d	n/d	n/d	n/d	n/d	n/d	n/a	n/d
C <sub>2</sub> H <sub>4</sub>	n/d	n/d	n/d	n/d	n/d	n/d	220=45	n/d	n/d	220=200	220=200	n/d	220=55
C <sub>2</sub> H <sub>4</sub> O	n/d	n/d	n/d	n/d	n/d	n/d	275=45	n/d	n/d	275=200	275=200	n/d	275=55
F <sub>2</sub>	n/d	n/d	n/d	n/d	2=0	n/d	n/d	n/d	n/d	n/d	n/d	n/d	n/d
CH <sub>2</sub> O	n/d	n/d	n/d	n/d	n/d	n/d	330=45	n/d	n/d	330=200	330=200	n/d	330=55
GeH <sub>4</sub>	n/d	1=1	n/d	n/d	2=0	n/d	n/d	n/d	n/d	n/d	n/d	n/d	n/d
N <sub>2</sub> H <sub>4</sub>	n/d	n/d	n/d	n/d	2=0	n/d	n/d	n/d	n/d	n/d	n/d	n/d	n/d
H <sub>2</sub> (ppm)	n/d	n/d	n/d	n/d	5=0	n/d	n/d	n/d	n/d	n/d	n/d	n/d	n/d
H <sub>2</sub> (LEL)	n/d	n/d	n/d	n/d	2=0	n/d	n/d	n/d	n/d	n/d	n/d	n/d	n/d
HBr	n/d	n/d	n/d	n/d	5=2.5	n/d	n/d	n/d	n/d	n/d	n/d	n/d	n/d
HCl	n/d	n/d	n/d	n/d	5=2.5	n/d	n/d	n/d	n/d	n/d	n/d	n/d	n/d
HCN	n/d	n/d	n/d	n/d	2=0	n/d	n/d	n/d	n/d	n/d	n/d	n/d	n/d
HF	yes n/d	n/d	n/d	3=4(theory)	yes n/d	n/d	n/d	n/d	yes n/d	n/d	n/d	n/d	n/d
H <sub>2</sub> S	n/d	n/d	n/d	n/d	5=<1	n/d	n/d	n/d	n/d	n/d	n/d	3=1	n/d
CH <sub>3</sub> OH	n/d	n/d	n/d	n/d	n/d	n/d	415=45	n/d	n/d	415=200	415=200	n/d	413=55
CH <sub>3</sub> SH	n/d	n/d	n/d	n/d	5=<2	n/d	n/d	n/d	n/d	n/d	n/d	2=1	n/d
NO	n/d	n/d	n/d	n/d	5=0	n/d	n/d	n/d	n/d	n/d	n/d	n/d	n/d
NO <sub>2</sub>	n/d	n/d	n/d	n/d	5=-0.025	n/d	n/d	n/d	n/d	n/d	n/d	n/d	n/d
O <sub>3</sub>	n/d	1=0.015	n/d	n/d	2=0	n/d	n/d	n/d	n/d	n/d	n/d	n/d	n/d
COCl <sub>2</sub>	n/d	n/d	n/d	n/d	2=0	n/d	n/d	n/d	n/d	n/d	n/d	n/d	n/d
PH <sub>3</sub>	n/d	1=0.56	n/d	n/d	2=0	n/d	n/d	n/d	n/d	n/d	n/d	n/d	n/d
SiH <sub>4</sub>	n/d	n/a	n/d	n/d	2=0	n/d	n/d	n/d	n/d	n/d	n/d	n/d	n/d
SO <sub>2</sub>	n/d	n/d	n/d	n/d	n/a	n/d	n/d	n/d	n/d	n/d	n/d	n/d	n/d
C <sub>4</sub> H <sub>6</sub> O <sub>2</sub>	n/d	n/d	n/d	n/d	n/d	n/d	200=45	n/d	n/d	n/a	200=200	n/d	200=55
C <sub>2</sub> H <sub>3</sub> Cl	n/d	n/d	n/d	n/d	n/d	n/d	200=45	n/d	n/d	200=200	n/a	n/d	200=55

n/a – not applicable

n/d – no data

### 9.3 Proper Application and Maintenance of Acrylonitrile Sensor

Acrylonitrile (ACN) is a very dangerous toxic gas that has OSHA and NIOSH TWA limits of 1 and 2 ppm respectively. It has an IDLH (Immediately Dangerous to Life and Health) limit of 85 ppm and a 15 minute ceiling limit exposure of 10 ppm.

The Detcon Model DM-700 Acrylonitrile Sensor is based on an electrochemical sensor which has certain limitations of use. Although it has good original span sensitivity to measure acrylonitrile, it has been known in certain application cases to lose sensitivity over time.

Continuous exposure to background ACN levels or repeated high ACN exposures will cause the sensor's response to ACN gas to be lost, and hence its useful life be shortened.

It is not reliably suitable for strict industrial hygiene monitoring where the application goal may be to assure that the ACN levels remain below the 2 ppm TWA limits.

When properly maintained it does offer the ability to function as gross leak detection method for ACN releases.

The lowest recommended scale range for ACN is 0- 50 ppm. The lowest recommended alarm set limit is 4 ppm.

Sensor Warranty is 6 months (this shortened warranty period reflects the vulnerability to unpredictable losses of sensitivity).

Using appropriate PPE, the sensor should periodically be span calibrated with ACN target gas (or occasionally bump tested with ACN target gas). However, frequent exposures to ACN during calibrations and bump testing will also shorten the life of the sensor. To address this, it is possible to use Carbon Monoxide (CO) as a cross-calibration gas, but CO may only be used if it is in combination with a program of periodic ACN bump testing that confirms the ultimate ability to adequately sense the ACN should a release occur. If the ACN bump test result is not acceptable, then a formal ACN span calibration must take place.

The end-user should work with Detcon to assure that a suitable amount of replacement Plug-in sensors are available on hand to handle the ongoing exchange of sensors that may require periodic replacement.

## 9.4 Spare Parts, Sensor Accessories, Calibration Equipment

Part Number	Spare Parts
927-245500-000	DM-700 Intelligent Transmitter Module (ITM for Toxic Gas Sensors)
927-345500-025	DM-700 Intelligent Transmitter Module (ITM for O <sub>2</sub> Sensors)
600-003803-000	Model DM-700 Splash Guard Adapter
377-xxxxxx-yyy	Replacement Plug-in toxic gas sensor (Refer to Table 4)
500-003087-100	Transient Protection PCA
<b>Sensor Accessories</b>	
897-850000-000	NEMA 7 Aluminum Enclosure with solid cover – 3 port
897-850000-316	NEMA 7 316SS Enclosure with solid cover – 3 port
613-120000-700	Sensor Splashguard with integral Cal Port
613-2R0000-000	Remote Calibration Adapter
943-002273-000	Harsh Environment Sensor guard
327-000000-000	Programming Magnet
960-202200-000	Condensation prevention packet (for J-Box replace annually)
<b>Calibration Accessories</b>	
943-000000-000	Calibration Wind Guard
943-000006-132	Threaded Calibration Adapter
943-050000-132	Span Gas Kit: Includes calibration adapter, span gas humidifier, 500cc/min fixed flow regulator, and carrying case. (Not including gas).
943-050000-HRG	Highly Reactive Gas Span Gas Kit (Used for NH <sub>3</sub> , Cl <sub>2</sub> , HCl, HBr, etc.)
See Detcon	Span Gases
943-05AM00-000	500 cc/min Fixed Flow Regulator for span gas bottle
<b>Recommend Spare Parts for 2 Years</b>	
927-245500-000	DM-700 Intelligent Transmitter Module (ITM for Toxic Gas Sensors)
927-345500-025	DM-700 Intelligent Transmitter Module (ITM for O <sub>2</sub> Sensors)
600-003215-000	Splash Guard Adapter
377-xxxxxx-yyy	Replacement Plug-in toxic gas sensor (Refer to Table 4)
500-003087-100	Transient Protection PCA
960-202200-000	Condensation prevention packet (for J-Box. Replace annually)

## 9.5 Model DM-700 Engineering Drawings

- 1) DM-700 Series Breakaway and Wiring
- 2) DM-700 Series Wiring and Dimensional, 316 SS conduit
- 3) DM-700 Series Wiring and Dimensional, Aluminum conduit
- 4) EC Smart Cell Installation

# 10. Revision Log

Revision	Date	Changes made	Approval
2.1	09/24/2008	Previous issue	N/A
2.2	04/26/2010	Adding diagram for installation of 377-XXXX01-YYY (EC smart sensor in Aluminum housing) to drawings. Added Revision Log	N/A
3.0	09/07/2010	Updated drawings to reflect recent changes (Aluminum conduit). Updated Table 2 to reflect new version of Smart EC sensor cell in Aluminum housing. Updated Replacement parts list Adding Dimensional and Breakaway drawings for 316SS and Aluminum Condulet to back of manual	N/A
3.1	11/08/2010	Updated Cross Interference table to correct wrong value on C2H3CL against CO. Old value was 1250=100, corrected value is 200=100	N/A
3.2	12/08/2010	Changed ATEX certification line under Electrical Classification in Section 9.1 from “Eex d [ib] ib IIC T6” to “II 2 G Ex d [ib] ib IIC T4” to match ATEX approval label for DM-700. Moved Revision Log from Appendix A to new Section 10 and added Approval column.	B.M.
3.3	04/28/2011	Updated drawings with sensor cell to show new label and position. Removed Teflon note in Section 2.5.	LU
3.4	07/11/2011	Added inrush current to specifications page	LU
3.5	04/16/2012	Changed cable recommendation, updated the Modbus Register Map, updated the spare part list	LU
3.6	01/07/2013	Updated ATEX approvals label, updated EN standards that sensor assembly meets. Updated ATEX listing in Specifications	BM
3.7	06/27/2013	Added information to Operational Guidelines	BM
3.8	11/11/2013	Updated approvals label and other updates	BM
3.9	11/20/13	Corrected Modbus™ Register Table	LU
4.0	12/25/13	Update Calibration to include Wind Guard	BM

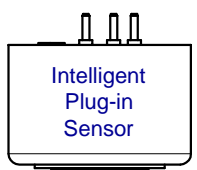
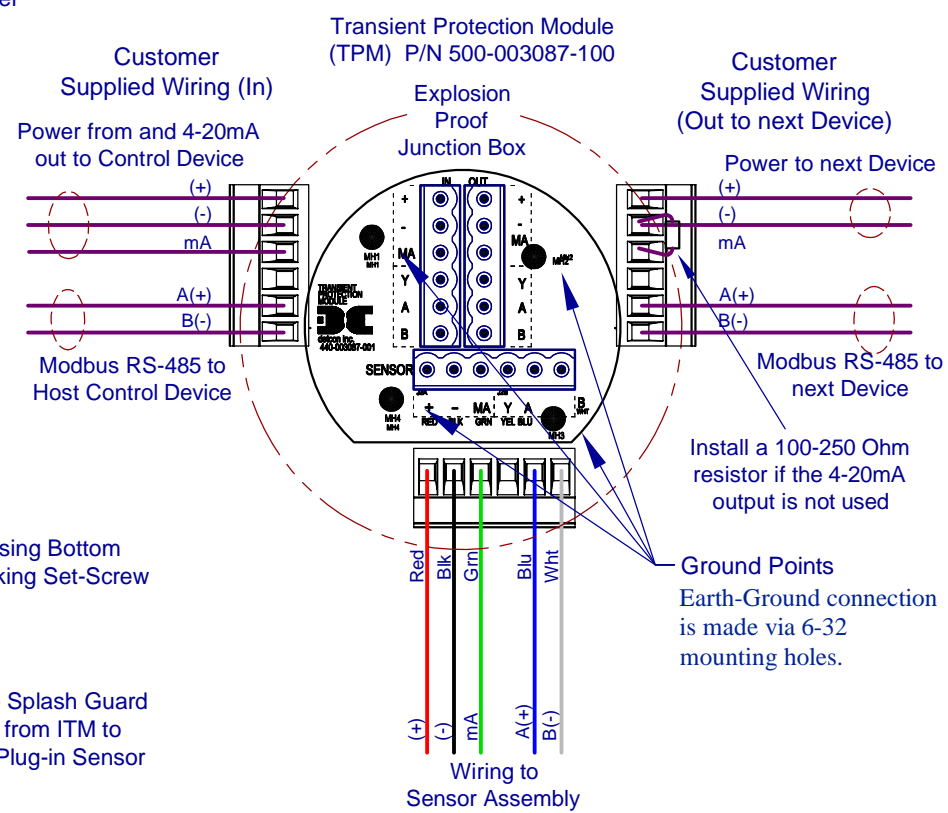
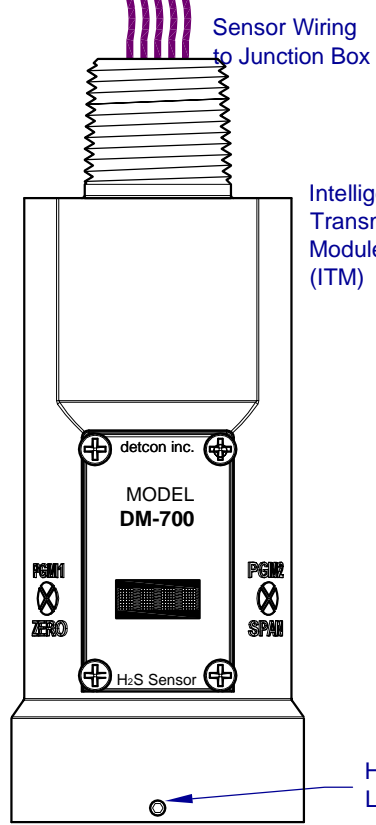

Remove Splash Guard Adapter from ITM to access Plug-in Sensor

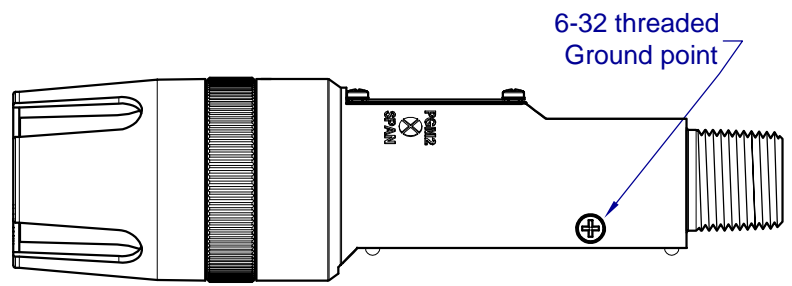
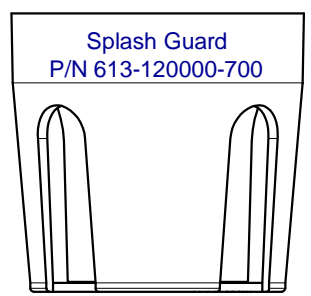
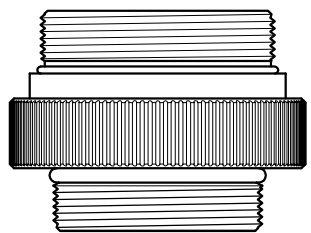

**NOTES:**

P.O. NO.	NA	The information and technical data disclosed by this document may be used and disseminated only for the purposes and to the extent specifically authorized by Detcon Incorporated in writing. Such information and technical data are proprietary to Detcon Incorporated and may not be used or disseminated except as provided in the foregoing sentence.
REQ. NO.	NA	
PROJECT NO.	NA	
SERIAL NO.	NA	
PLANT:	NA	

REV	DATE	DESCRIPTION	DRN	CHKD	APPD	DWG #	SUBJECT
6	11/11/13	Changes to Splashguard and housing	RH	EM	BM	3207	UPDATE
5	06/25/10	New ECS Assembly	RH	SF	BM	3207	ECO-
4	01/14/08	Removed Yelow Wire	RH	SF	BM	3207	UPDATE
3	04/01/07	TPM CHANGED	RH	EM	BM	3207	UPDATE
2	11/28/06	Correct pinout on TPM	RH	EM	BM	3207	UPDATE
1							

**DETCON INC.**  
 3200 Research Forest Dr. A-1 \* The Woodlands Texas 77381 \* www.detcon.com

CLIENT: NA  
 PROJECT: NA  
 DRAWN BY: R HUTSKO  
 SCALE: NTS  
 FIRST ISSUE: 03/30/06

**DM-700 Series Breakaway and Wiring**

SALES ORDER NO. NA  
 SHEET NUM. NA  
 DRAWING NO. 3207-1  
 SIZE: A  
 REV: 6

This page left intentionally blank

Shipping Address: 4055 Technology Forest Blvd., The Woodlands Texas 77381  
Mailing Address: P.O. Box 8067, The Woodlands Texas 77387-8067  
Phone: 888.367.4286, 281.367.4100 • Fax: 281.292.2860 • [www.detcon.com](http://www.detcon.com) • [sales@detcon.com](mailto:sales@detcon.com)

Conduit

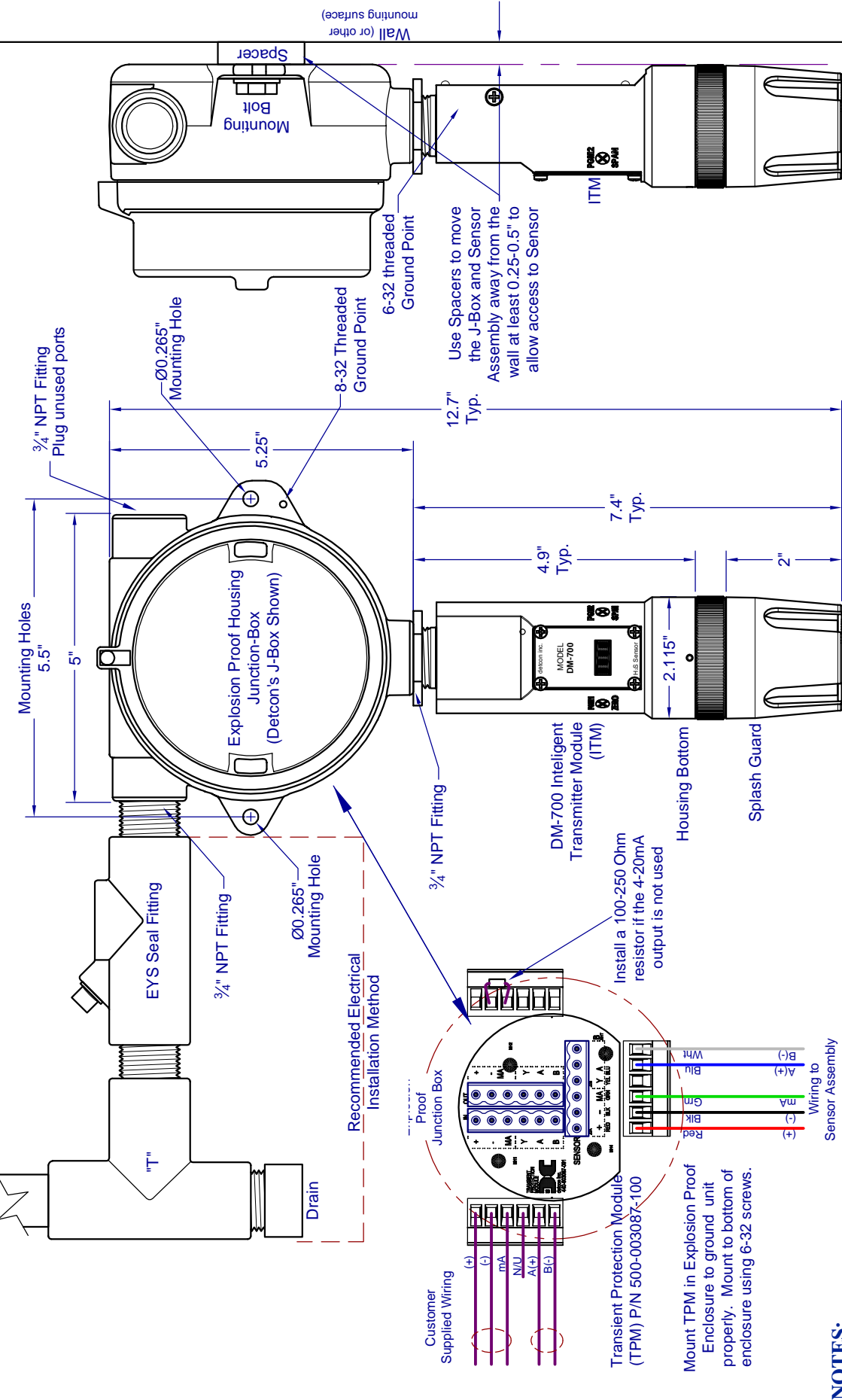

**Recommended Electrical Installation Method**

Customer Supplied Wiring  
 (+) (-) MA MA  
 NLU A(+) B(-)

Transient Protection Module (TPM) P/N 500-003087-100

Mount TPM in Explosion Proof Enclosure to ground unit properly. Mount to bottom of enclosure using 6-32 screws.

Install a 100-250 Ohm resistor if the 4-20mA output is not used

Wiring to Sensor Assembly  
 (+) (-) A(+) A(-) B(+) B(-)  
 WHR Blue  
 BK Black  
 GR Green  
 RD Red

**NOTES:**

If the Sensor is not mechanically grounded to the Junction Box, and external ground strap should be used to insure proper grounding.

PO. NO.	REQ. NO.	SERIAL NO.	PLANT:	DESCRIPTION	DATE	BY	CHKD	APPD	DWG. NO.	SUBJECT	REF. DWGS
NA	NA	NA	NA	Changes to Splicing and housing	11/11/13	EM	EM	EM	3207	UPDATE	
NA	NA	NA	NA	New ECS Assembly	06/25/10	RH	SF	EM	3207	ECD	
NA	NA	NA	NA	Removed Yellow Wire	01/14/08	RH	SF	EM	3207	UPDATE	
NA	NA	NA	NA	TPM CHANGED	04/01/07	RH	EM	EM	3207	UPDATE	
NA	NA	NA	NA	Correct pinout on TPM	11/28/06	RH	EM	EM	3207	UPDATE	
NA	NA	NA	NA	DISCUSSION	03/30/06	EM	EM	EM	3207	UPDATE	

**REVISION HISTORY**

**DETCON INC.**  
 3200 Research Forest Dr., A-1 • The Woodlands, Texas 77381 • www.detcon.com

**DM-700 Series**  
 Wiring, Dimensional, and Mounting

CLIENT: NA  
 PROJECT: NA  
 DRAWN BY: R. Hutsko  
 SCALE: NTS  
 SALES ORDER NO.: NA  
 FIRST ISSUE: 03/30/06  
 SHEET NUM: NA

DETCON INC. 3200 Research Forest Dr., A-1 • The Woodlands, Texas 77381 • www.detcon.com

This page left intentionally blank

Shipping Address: 4055 Technology Forest Blvd., The Woodlands Texas 77381  
Mailing Address: P.O. Box 8067, The Woodlands Texas 77387-8067  
Phone: 888.367.4286, 281.367.4100 • Fax: 281.292.2860 • [www.detcon.com](http://www.detcon.com) • [sales@detcon.com](mailto:sales@detcon.com)



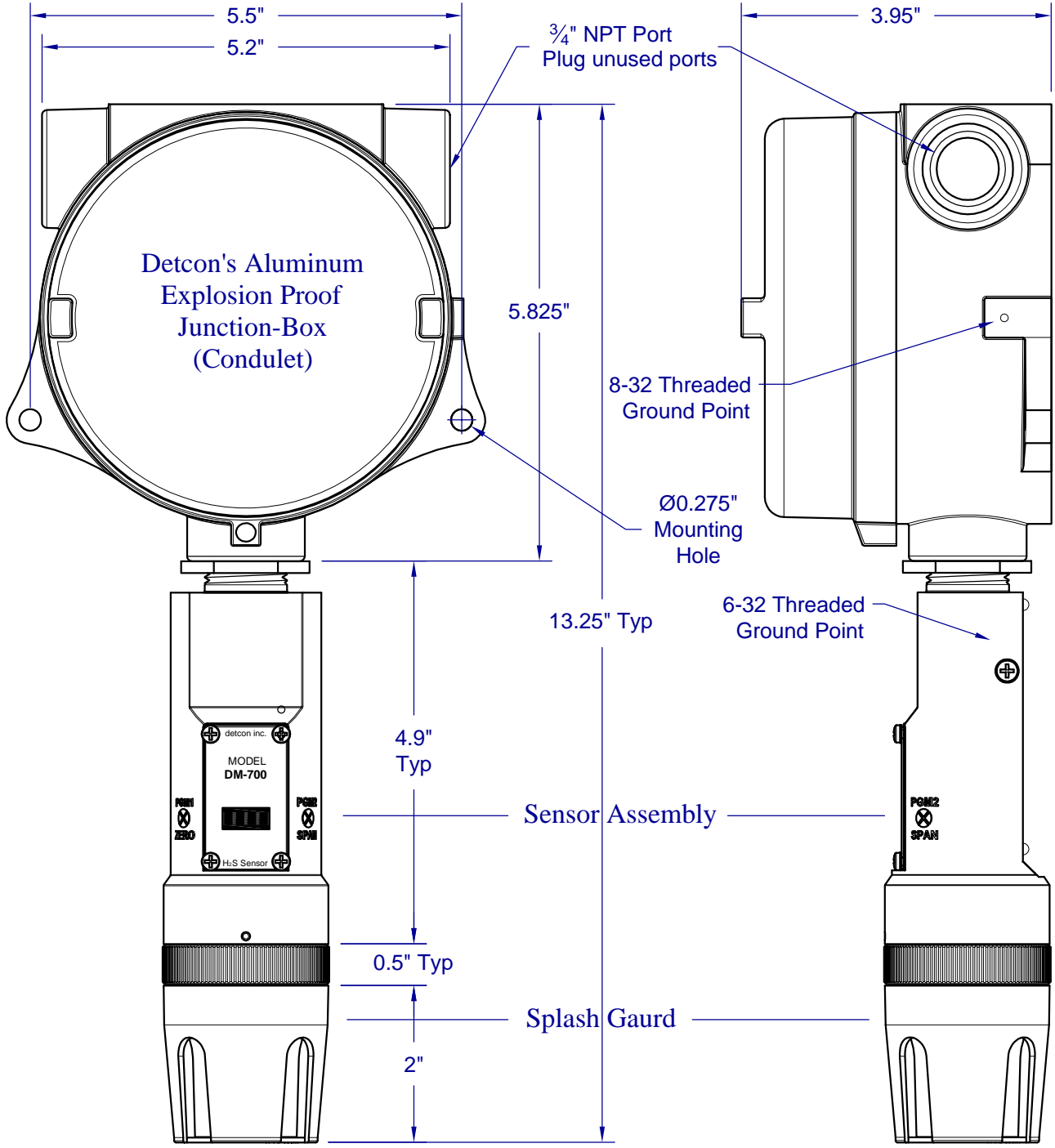

**NOTES:**

P.O. NO.	NA
REQ. NO.	NA
PROJECT NO.	NA
SERIAL NO.	NA
PLANT:	NA

The information and technical data disclosed by this document may be used and disseminated only for the purposes and to the extent specifically authorized by Detcon Incorporated in writing. Such information and technical data are proprietary to Detcon Incorporated and may not be used or disseminated except as provided in the foregoing sentence.

Rev	DATE	DESCRIPTION	DRN	CHKD	APPD	DWG #	SUBJECT
6	11/11/13	Changes to Splashguard and housing	RH	EM	BM	3207	UPDATE
5	06/25/10	New ECS Assembly	RH	SF	BM	3207	ECO-
4	01/14/08	Removed Yellow Wire	RH	SF	BM	3207	UPDATE
3	04/01/07	TPM CHANGED	RH	EM	BM	3207	UPDATE
2	11/28/06	Correct pinout on TPM	RH	EM	BM	3207	UPDATE

 <b>DETCON INC.</b> <small>3200 Research Forest Dr. A-1 * The Woodlands Texas 77381 * www.detcon.com</small>			
CLIENT:	NA	<b>DM-700 Series with Detcon Aluminum Junction-Box</b>	
PROJECT:	NA		
DRAWN BY:	R HUTSKO	SCALE:	NTS
FIRST ISSUE:	06/25/10	SALES ORDER NO.:	NA
REF. DWGS		SHEET NUM.:	NA
		SIZE:	A
		REV:	6

This page left intentionally blank

Shipping Address: 4055 Technology Forest Blvd., The Woodlands Texas 77381  
Mailing Address: P.O. Box 8067, The Woodlands Texas 77387-8067  
Phone: 888.367.4286, 281.367.4100 • Fax: 281.292.2860 • [www.detcon.com](http://www.detcon.com) • [sales@detcon.com](mailto:sales@detcon.com)