

Thank you for choosing a NIVELCO instrument.
We are sure that you will be satisfied throughout its use!

NIVOCONT

VIBRATING ROD LEVEL SWITCHES

USER'S MANUAL

1. APPLICATION

The NIVOCONT vibrating rod level switches are suitable for low and high level indication of granules and powders with a min. 0.05 kg/dm³ density such as cement, lime, sand, grain, feed, sugar, etc. Dust Ex versions are available for using the instrument in explosion-proof environment.

2. TECHNICAL DATA

2.1 GENERAL SPECIFICATION

VERSION	STANDARD	PIPE EXTENDED	CABLE EXTENDED
Probe length	207 mm	0.3 ... 3 m	1 ... 20 m
Material of wetted parts	1.4571		Probe: 1.4571 Cable: PE coated
Housing material	Aluminium: Powder paint coated (R-500 series) Plastic: PBT fibre-glass reinforced, flame-retardant (R-600 series)		
Process connection	R_H; R_R; R_K: 1/2" BSP R_N; R_L; R_C: 1/2" NPT		
Temperature ranges	See table 2.2 and Temperature diagram		
Max. pressure (absolute)	25 bar (2.5 MPa)	6 bar (0.6 MPa)	
Minimum medium density ⁽¹⁾	0.05 kg/dm ³ (max. granular size: 10 mm)		
Response time	< 1.8 sec or 5 ± 1.5 sec		
(selectable)	Vibrating (covered) < 2 sec or 5 ± 1.5 sec		
Supply voltage (universal)	normal type: 20...255 V AC/DC Ex type: 20...250 V AC (50/60Hz) or 20...50V DC		
Power consumption	≤ 2.5 VA / 2 W		
Electrical connections	2 pcs. M20x1.5 cable glands with Ex ta IIIC protection type or for normal types M20x1.5 plastic glands for cable Ø 6 to 12 mm, 2 pcs. plug-in type terminal blocks for 0.25 to 1.5 mm ² wire cross section internal thread for 2x 1/2" NPT cable protective pipe		
Ingress protection	Housing: IP67		
Electrical protection	Class I. (to be grounded!)		
Ex protection mark	ATEX	II 1/2D Ex ta/IIIC T90 °C...T170 °C Da/Db	
	IECEX	Ex t IIIC T* Da/Db IP67 -30°C ≤ Tamb ≤ +60°C *(see table 2.2)	
Mass	plastic housing	1.5 kg	1.5 kg (+ 1.4 kg/m)
	aluminium housing	1.88 kg	1.88 kg (+ 1.4 kg/m)

⁽¹⁾ Depend on friction and granular size of the medium

2.2 SPECIAL DATA

TEMPERATURE DATA	CABLE EXTENDED VERSION			STANDARD AND PIPE EXTENDED VERSION				HIGH TEMP. RH_-5_-5Ex, RT_-5_-5Ex
	R_K-5_-5Ex R_C-5_-5Ex			RK_-5_-5Ex, RS_-5_-5Ex with the exception of the cable extended version				
Medium temperature min.: -30°C ... max.: ⁽³⁾	+60°C	+70°C	+80°C ⁽²⁾	+60°C	+70°C	+95°C	+110°C	+160°C
Ambient temperature range min.: -30°C ... max.: ⁽³⁾	+60°C	+50°C	+60°C	+60°C	+50°C	+60°C	+50°C	+35°C
Max. surface temperature of process connection	+85°C	+85°C	+95°C	85°C	85°C	+95°C	+95°C	+135°C
Max. surface temperature	+85°C	+85°C	+95°C	85°C	85°C	+95°C	+110°C	+160°C
Temperature class	T90°C			T100°C	T90°C	T100°C	T115°C	T170°C

⁽²⁾ Medium temperature for max. 1 hour + 95 °C

⁽³⁾ To operate the level switch with the maximum values of the related temperature data the applied cable should permanently withstand up to +90 °C temperature.

OUTPUT DATA	RELAY		SOLID STATE
	R_-5_-1	R_-5_-5Ex	R_-5_-3
Output type	SPDT (potential free)		SPST (electronic)
Output rating	250 V AC, 8A, AC 1		50 V, 350 mA peak
Output protection	—		Overvoltage, overcurrent and overload
Voltage drop (switched on)	—		< 2.7 V @ 350 mA
Residual current (switched off)	—		< 10 µA

TEMPERATURE DIAGRAM

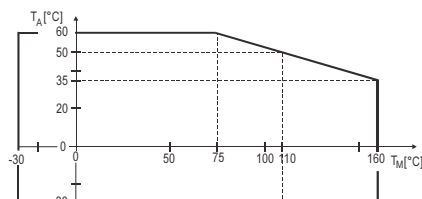

Figure 2.
Ambient temperature (Ta) versus medium temperature (Tm)

2.4 ORDER CODE

NIVOCONT R [] [] - [] [] - [] *

VERSION	CODE	PROCESS. CONN.	CODE			HOUSING	CODE	PROBE LENGTH	CODE			SUPPLY / OUTPUT / Ex	CODE
Standard	K	1 1/2" BSP	Standard	Pipe	Cable	Alu cast	5	207 mm	Standard	Pipe	Cable	20-255 V AC/DC / Relay	1
Standard polished	S	1 1/2" NPT	H	R	K	Plastic	6	0.3 ... 3 m	—	03...30	—	20-255 V AC/DC / Electronic	3
High temp.	H ⁽⁴⁾		N	L	C			1 ... 20 m	—	—	01...20	20-250 V AC or 20-50 V DC / Relay / Ex	5
High temp. polished	T ⁽⁴⁾												

⁽⁴⁾ only for standard and pipe extended versions



NIVELCO

Manufacturer: NIVELCO Process Control Co.

H-1043 Budapest, Dugonics u. 11.

Telefon: (36-1) 889-0100 ■ Fax: (36-1) 889-0200

E-mail: sales@nivelco.com ■ www.nivelco.com

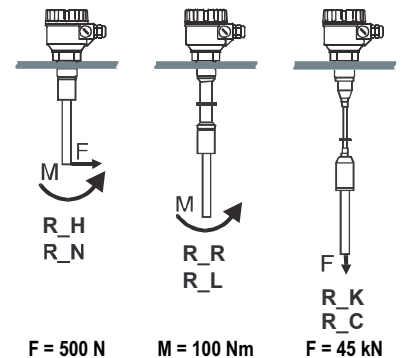

Figure 1.
Maximum allowed torque and force

2.3 ACCESSORIES

- User's manual
- Warranty Card
- Declaration of Conformity
- 2 pcs. 3-pole terminal blocks
- 1 1/2" sealing, for BSP only
- 2 pcs. M20x1.5 cable glands

* The order code of an Ex version should end in „Ex“

2.5 DIMENSIONS

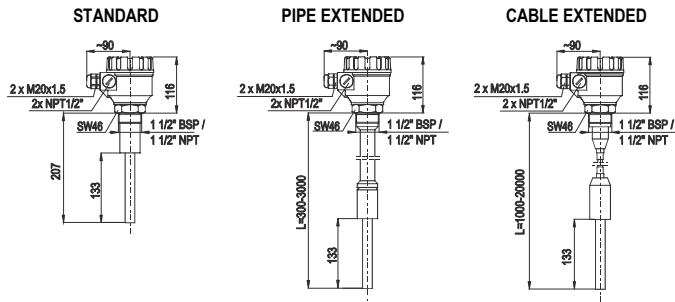

Figure 3.

3. MOUNTING

Prior to installation, it is advised to check the switching function for proper adjustment on a sample quantity of material (see: Adjustment). The unit may not work with mediums within the specified density range but having very large size of granules or extremely little friction.

WARNING! Handle the device with great care, especially the sensing probe. Any impact on the sensing probe may ruin its resonance system. A protective shield should be installed (see Figure 6) if the probe is exposed to falling material or excessive mechanical load.

Screw in the device by its hexagon neck. After screwing tight the process connection, the housing can be rotated (max. 300°), to adjust the cable gland to the required position.

It might be necessary to install the device at an offset level position relative to the switching level actually required taking into account caving or arching of the material in the silo (see Figure 4).

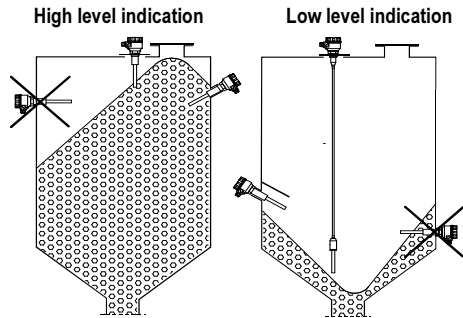

Figure 4.

With powder level detection device should be installed at an inclination exceeding the angle of repose (or, in case of high level detection vertically), to prevent powder deposition on vibrating rod that might substantially reduce the self-cleaning effect. Also avoid mounting the rod in a recess (see Figure 5)

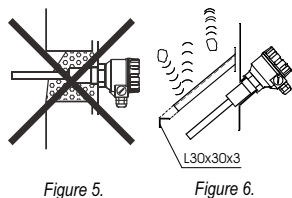

Figure 5.

Figure 6.

In case of tanks that are likely to be exposed to intense vibrations, necessary provisions shall be made for damping the vibrations acting on the device (e.g. vibration damping inserts made of rubber have to be applied).

4. INSTALLATION, PUTTING INTO OPERATION

Remove the top cover of the housing to access the connection terminals and adjusting switches. In case of Dust Ex instruments the housing cover can be only opened after the removal of the socket cap screw fixed safety locking bolt.

Do not remove the wire form terminal pin 1 (Figure 7) because it is an internal connection. For grounding the unit use the PE (Protective Earth) grounding screw.

After proper installation and the electrical connection, established the device is ready for operation. The switched-on state is indicated by the lighting of the LED.

The DENSITY (switch A) switch is to be set in accordance with the density of the material:

- LOW position, recommended for loose and light materials with density below 0.1 kg/dm³ represents small energy and amplitude of vibration as well as great sensitivity of detection.
- HIGH position, recommended for (thick and heavy) materials with density over 0.1 kg/dm³ represents vibration with great energy and amplitude and small sensitivity of detection

The instrument may not switch correctly in mediums with density less than 0.05 kg/dm³ or with very small internal friction.

To obtain FAIL SAFE alarm (switch C), use the de-energised or open state of the output as an alarm, thus a power breakdown will also be considered as alarm (see Table below).

The delay (switch B) is to be selected to comply with requirements of the process control technology the units is used for.

Note: The instrument may be damaged via switches by electrostatic discharge (ESD), thus the precautions commonly used to avoid ESD is to be applied.

5. WIRING

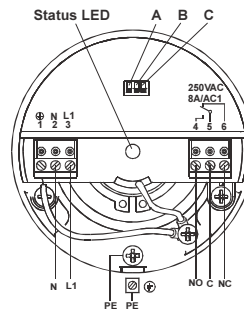

Figure 7.

Wiring of relay output version

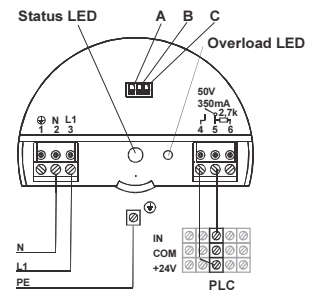

Figure 8.

Wiring of optocoupled sink input to solid state output version supplied from a AC line

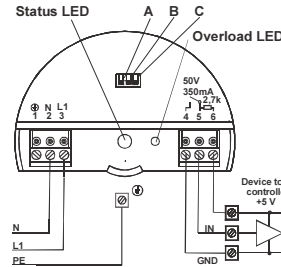

Figure 9.

Wiring of a logical voltage input to a solid state output version supplied from a AC line

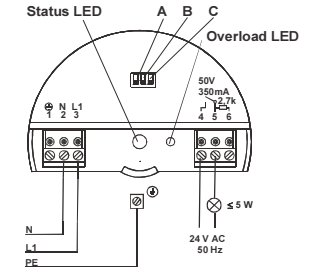

Figure 10.

Wiring of a load to a solid state output version supplied from a AC line

5.1 OPERATION DIAGRAM

POWER	PROBE	FAIL-SAFE MODE	LED	RELAY	SOLID STATE OUTPUT
ON	NOT VIBRATING (COVERED)	LOW	GREEN	5-4 6-6 ENERGISED	6-2.7k 4-5 ON
		HIGH	RED	5-4 6-6 DE-ENERGISED	6-2.7k 4-5 OFF
	VIBRATING (FREE)	LOW	RED	5-4 6-6 DE-ENERGISED	6-2.7k 4-5 OFF
		HIGH	GREEN	5-4 6-6 ENERGISED	6-2.7k 4-5 ON
FAILS		LOW or HIGH	NOT LIT	5-4 6-6 DE-ENERGISED	6-2.7k 4-5 OFF

5.2 SPECIAL CONDITIONS FOR SAFE USE

The enclosure shall be not opened while it is energized!

The IECEx certified apparatus may be used only in explosive dust atmospheres where the temperature class of the selected type of the apparatus does not exceed two-third parts of the minimum ignition temperature of the dust/air mixture.

The IECEx certified equipment must be assembled with cable glands certified according to protection Ex t IIIC IP67, size M20x1.5

In hazardous atmosphere environment the unit can be only powered on after properly closing the housing cover and fixing the screws of the safety locking bolt.

6. MAINTENANCE AND REPAIR

The NIVOCONT R-500/R-600 series devices do not require maintenance on a regular basis. In some instances, however, the vibrating section may need a cleaning from deposited material. **This must be carried out gently, without harming the vibrating section of the vibrating rod.**

Repairs during or after the warranty period are effected at the Manufacturers. The equipment sent back for repairs should be cleaned or neutralised (desinfected) by the User.

7. STORAGE

Ambient temperature: -35 ... +60°C

Relative humidity: max. 98 %

8. WARRANTY

NIVELCO provides warranty of 3 (three) years in compliance with details described in the Warranty Card.

rkh5021a0600h_06
April 2016

NIVELCO reserves the right to change technical data without notice.