



Pressure switch for hygienic and general applications: Monitoring of absolute or relative pressure in gases, vapors, liquids and dust

In brief

- 
 4...20mA
2x PNP
- fast
response time

- 385.2
helle LED
Anzeige
- closed
operating
interface
- capacitive
ceramic
sensor

- display and
housing
rotatable

Application

- General applications in
 - Machinery and plant engineering
 - Air-conditioning and refrigeration plant engineering
 - Hydraulic and pneumatic systems
 - Process industry
 - Environmental technology

Your benefits

- *Wide range of applications*
- Finely graded measuring ranges from 100 mbar up to 60 bar
- Wide process temperature range -40°C to +125°C
- Wide variety of process connections
- High protection class IP65 / IP67
- Wide environmental temperature range -40°C to +85°C
- Ceramic *front-flush or internal diaphragm*
- Increased accuracy – characteristic deviation ≤ 0,2% of measuring range
- Integrated evaluation electronic: Digital display, function LED's, keyboard / 2x PNP switch output / 1x current output 4...20mA / Connector plug M12
- *High operating comfort*: enclosure and display rotatable for *optimal operability* in each installation position
- Robust high brightness LED display for *best readability*
- 3-key operation without additional assistance with tactile feedback

Description

Due to the device construction with measuring ranges from -1 bar to 60 bar (gauge), measuring ranges from 0 bar to 60 bar (absolute), measuring spans from 100 mbar to 60 bar, process temperatures from -40°C to +125°C and process materials high purity Al2O3-ceramic / CrNi-steel as well as the availability of industrial standard process connections like thread ISO 228-1 (EN 837 manometer / inner thread / front-flush), dairy coupling DIN 11851 (front-flush), Varivent® (ront-flush), clamp ISO 2852 / BS 4825 / DIN 32676 (front-flush) and DRD (front-flush) the device is especially suitable for the use for machinery and plant engineering, air-conditioning and refrigeration plant engineering, hydraulic and pneumatic systems, process industry, environmental technology and facility and building automation.

The device is suitable for demanding measuring requirements. Due to its high accuracy and the high flexibility of configuration, the device can be suited a wide variety of applications. Through its optimized design, the front-flush process connection enables the cleanability of the wetted diaphragm to be integrated into the process. The device is suitable for the use at CIP/SIP cleaning processes. Low-maintenance and trouble-free pressure measurement is thus also guaranteed in critical applications with frequently changing media. The robust design and the high-quality workmanship turns the device into a very high quality product, which even the most adverse environmental conditions cannot affect, whether the lowest temperatures when used outdoors, extreme shock and vibration or aggressive media.



A captive laser marking of the type label ensures the identifiability throughout the entire lifetime of the device. Obviously is the optional marking of a measurement point designation resp. TAG, a customer label or of a neutral type label, of course also per laser marking. A LABS-free resp. silicone-free version, a factory calibration with calibration certificate and a customer specific configuration resp. preset is also optionally available like a material test certificate EN10204 3.1 or factory certifications for drink water resp. food suitability.

Technical Data	
Supply voltage:	10,5...35VDC, reverse polarity protected
Supply current:	≤ 60mA Analogue output max. 22,5mA Switch output with no load
2xPNP-switch output	
Function:	PNP switch to +L
Output current:	0... ≤ 200mA current limited, short circuit protected
Analogue output 4...20mA	
Operating range:	3,9...21mA, min. 3,8mA, max. 22mA
Permitted load:	≤ (US - 10,5V) / 22mA
Start-up time:	≤ 1 ms
Measuring accuracy	
Characteristic deviation:	≤ ± 0,2% FS
Long term drift:	≤ ± 0,1% FS / year not cumulative
Temperature deviation	Zero: ≤ ±0,015% FS / K, max. ±0,75% (-20°C...+80°C) Span: ≤ ±0,015% FS / K, max. ±0,5% (-20°C...+80°C / > 400mbar), max. ±0,8% (-20°C...+80°C / ≤ 400 mbar)
Materials	
Diaphragm: (process wetted)	Measuring range ≤ 1bar: Ceramic Al ₂ O ₃ - 99,7% (SIP suitable) Measuring range ≥ 1,6bar: Ceramic Al ₂ O ₃ - 96% (SIP suitable) Process connection 1/2/4/6/7/N/M/P/L/S/T: Ceramic Al ₂ O ₃ - 99,9% (CIP/SIP suitable)
Process connection: (process wetted)	Steel 1.4404/316L / Steel 1.4571/316Ti
Terminal enclosure:	CrNi-steel
Gaskets: (process wetted)	FPM – fluorelastomere (e.g. Viton®) EPDM – ethylene-propylene-dienmonomere, FDA-listed FFKM – perfluorelastomere (e.g. Kalrez®) FFKM hd – perfluorelastomere high density
Environmental conditions	
Environmental temperature:	- 40°C... +85°C
Process temperature:	-40...+100°C (extended -40...+125°C)
Process pressure:	- 1 bar ...60 bar (depending on process connection)
Protection:	IP65/IP67 EN/IEC 60529

Electrical connection

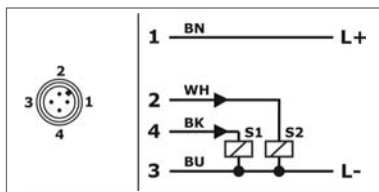

Signal 2x PNP
Conductor color standard connection cable M12
- A-coded: BN = brown, WH = white, BU = blue, BK = black

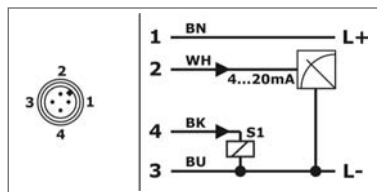

Signal 4...20 mA / 1x PNP
Conductor color standard connection cable M12
- A-coded: BN = brown, WH = white, BU = blue, BK = black

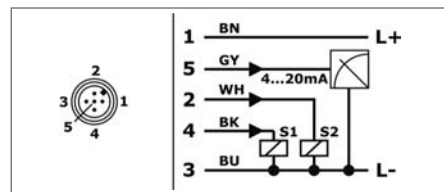

Signal 4...20 mA / 2x PNP
Conductor color standard connection cable M12 - A-coded:
BN = brau brown n, WH = white, BU = blue, BK = black, GY = grau

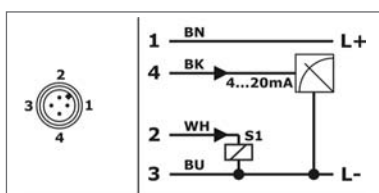

Signal 4...20 mA / 1x PNP / Desina
Conductor color standard connection cable M12
- A-coded: BN = brown, WH = white, BU = blue, BK = black

Terminal enclosure

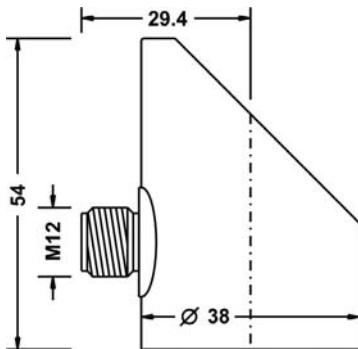

Type 1 – Thread ISO 228-1 – G½”A, EN 837

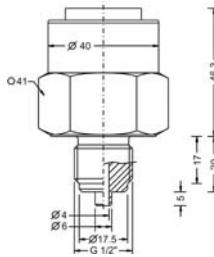

Type 9 – Thread ISO 228-1 – G½”B, front-flush

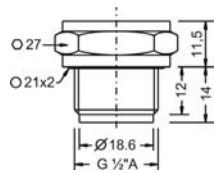

Type 7 – Thread ISO 228-1 – G1½”B, front-flush

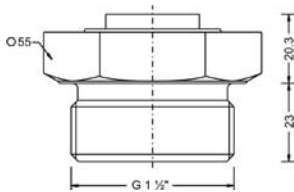

Type M – Dairy coupling DIN 11851 – DN50, PN25

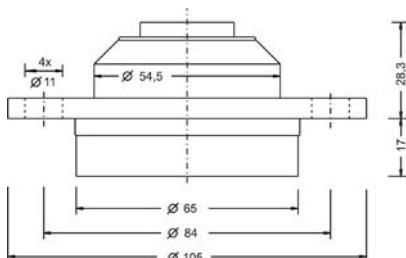

Temperature decoupler

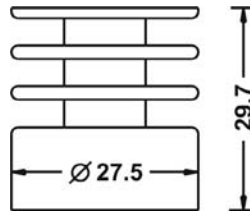

Type 4 – Thread ISO 228-1 – G¼”I, inner thread

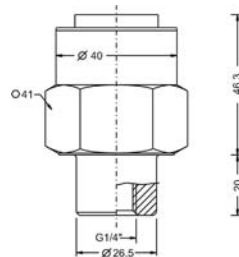

Type 8 – Thread ISO 228-1 – G¾”A, front-flush

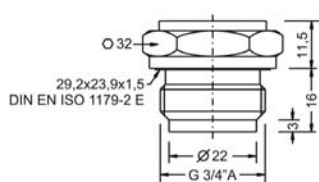

Type R – Dairy coupling DIN 11851 – DN25, PN40

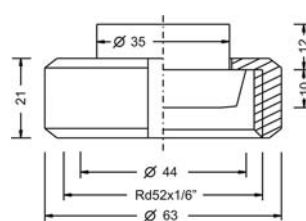

Type P – Varivent® – Type N / tube DN40-162 / 1½”-6”, PN40

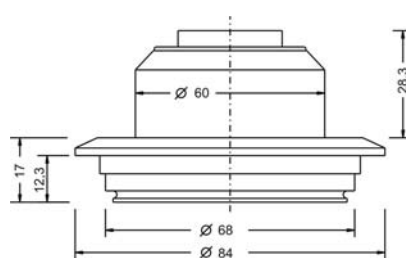

Type 6 – Thread ISO 228-1 – G¼”A, EN 837

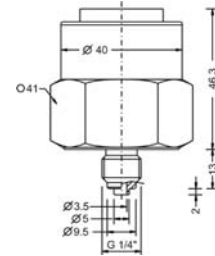

Type 2 – Thread ISO 228-1 – G½”A, inner bore

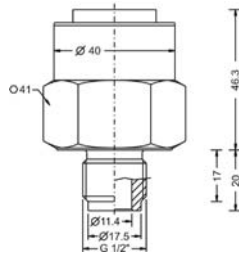

Type 5 – Thread ISO 228-1 – G1”A, front-flush

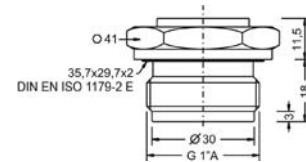

Type N – Dairy coupling DIN 11851 – DN40, PN25

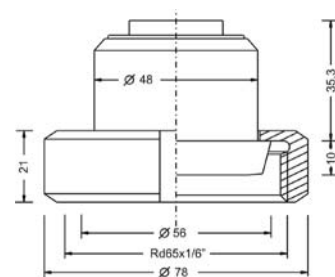

Type L – DRD – DN50 / Ø65mm, PN25

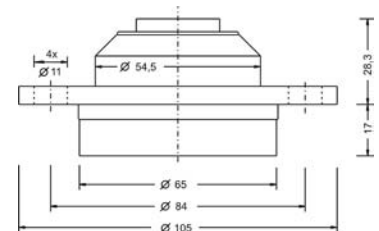

<p>PS4S</p> <p>C</p> <p>S</p> <p>V</p> <p>C</p> <p>S</p> <p>1</p> <p>S</p>	<p>Type Standard</p> <p>Measuring system – material diaphragm (process wetted) / sensor type / accuracy Ceramic Al2O3 96%/99,7%/99,9% / capacitive</p> <p>Approval Standard</p> <p>Process connection</p> <p>6 Thread ISO 228-1 – G¼"A, EN 837 manometer 1 Thread ISO 228-1 – G½"A, EN 837 manometer 4 Thread ISO 228-1 – G¼"I, inner thread 2 Thread ISO 228-1 – G½"A, inner bore 9 Thread ISO 228-1 – G½"B, front-flush, ≤ 20 bar 8 Thread ISO 228-1 – G¾"A, front-flush, ≤ 20 bar 5 Thread ISO 228-1 – G1"A, front-flush, ≤ 20 bar 7 Thread ISO 228-1 – G1½"B, front-flush R Dairy coupling DIN 11851 – DN25, PN40, ≤ 20 bar N Dairy coupling DIN 11851 – DN40, PN25 M Dairy coupling DIN 11851 – DN50, PN25 P Varivent® – Type N / tube DN40-162 / 1½"-6", PN40 L DRD – DN50 / Ø65mm, PN25 S Clamp ISO 2852 – DN25-38 / BS 4825 – 1"-1½" / DIN 32676 – DN25-38, PN25 T Clamp ISO 2852 – DN40-51 / BS 4825 – 2" / DIN 32676 – DN50, PN25 Y others</p> <p>Material process gaskets (process wetted)</p> <p>1 FPM – fluorelastomere (e.g. Viton®) 3 EPDM – ethylene-propylene-dienmonomere, FDA-listed 4 FFKM - perfluorelastomere (e.g. Kalrez®) 6 FFKM hd - perfluorelastomere high density - gas applications Y others</p> <p>Material process connection (process wetted) V CrNi-steel</p> <p>Material terminal enclosure C CrNi-steel</p> <p>Measuring range</p> <p>01 0...100 mbar 02 0...200 mbar 03 0...400 mbar 04 0...600 mbar 05 0...1 bar 06 0...1,6 bar 07 0...2,5 bar 08 0...4 bar 09 0...6 bar 10 0...10 bar 11 0...16 bar 12 0...20 bar 13 0...40 bar 14 0...60 bar 15 -100...0 mbar 16 -1...0 bar 17 -1...+1 bar 18 -100...+100 mbar YY Special measuring range</p> <p>Electronic – output</p> <p>A 2x switch PNP, supply 24VDC B 1x switch PNP, 1x signal 4...20mA , supply 24VDC C 2x switch PNP, 1x signal 4...20mA, supply 24VDC D 1x switch PNP, 1x signal 4...20mA, supply 24VDC, Desina</p> <p>Electronic – function S Standard</p> <p>Process temperature</p> <p>0 Standard -40°C...+100°C 1 Extended -40°C...+125°C, temperature decoupler</p> <p>Pressure type</p> <p>R Gauge pressure A Absolute pressure, ≥ 1 bar</p> <p>Measuring system – accuracy 1 0,2%</p> <p>Electrical connection S Plug M12x1</p>
--	---

Order code

Precont® PS4S C S V C S 1 S

Equipment

Order information
BKZ0412-VA
BKZ0512-VA
LKZ0405PUR-AS
LKZ0410PUR-AS
LKZ0505PUR-AS
LKZ0510PUR-AS

Model
Matching cable socket, VA-nut
Matching cable socket, VA-nut
Connection cable 5 m, 4-pole, shielded
Connection cable 10 m, 4-pole, shielded
Connection cable 5 m, 5-pole, shielded
Connection cable 10 m, 5-pole