

SCOTT[®]

HEALTH & SAFETY

4600 MB Gas Transmitter Operation & Maintenance Manual

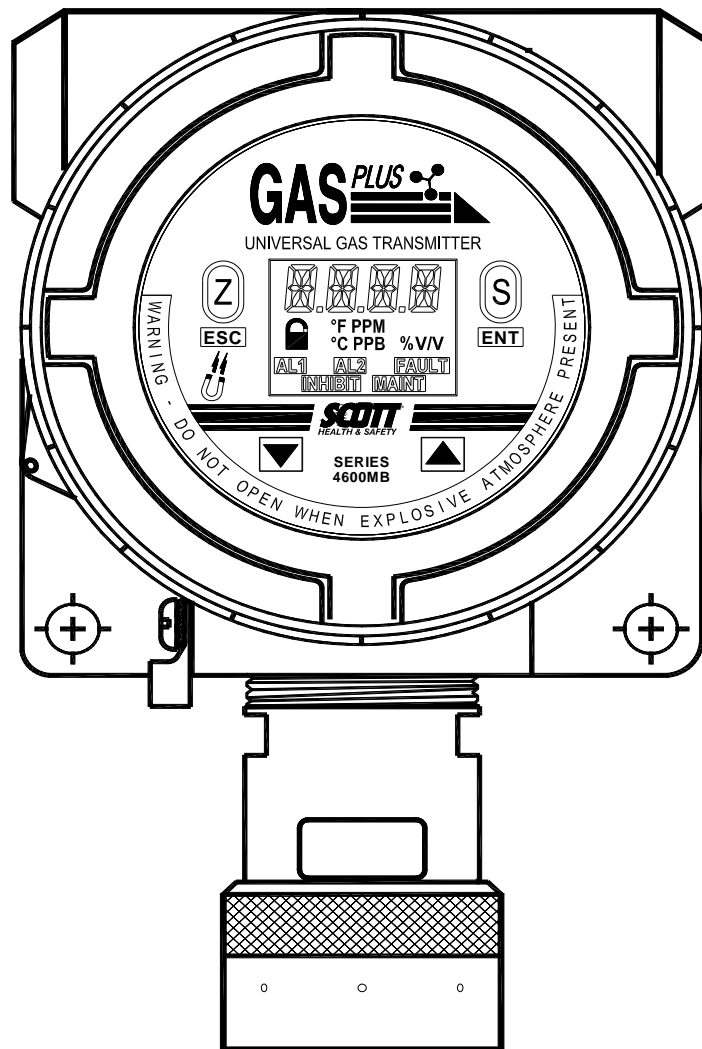

Rev: 4600MB(D)
Date: 4/11/08
ECN: 129032
Part#: 087-0014

Contents

General Instrument Overview Map _____	1
Introduction	
SCOTT HEALTH & SAFETY Gas Sensor _____	3
Overview of Sensor Operation _____	3
The Sensor and Battery _____	3
Gas Specificity _____	4
Sensor Accuracy _____	4
Sensor Response Times _____	4
Sensor Life _____	4
Environmental Influences to the Sensor _____	5
Sensor Oxygen Requirements _____	5
Sensor Intrinsic Safety _____	6
Sensor Handling and Disposal _____	6
Installation	
Location Considerations _____	7
Physical Installation and Wiring _____	7
Remote Sensor Junction Box Mounting _____	8
Powering the Transmitter _____	9
Sensor Installation _____	20
Twist and Lock Accessories _____	21
Transmitter Operation	
Navigating the Instrument _____	24
RUN Mode _____	24
How to Adjust Transmitter Parameters _____	24
Acknowledging Latched Alarms _____	25
Inhibiting Output _____	25
Calibration Frequency _____	26
Remote Sensor Calibration _____	27
Storing Sensors _____	28
Zero Calibration _____	28
Span Calibration _____	29
Important Notes of Calibration of Sensors _____	31
Weekly Operational Response Checks _____	33
Adjusting the Loop Output Parameters _____	33
Optional Alarm Relays _____	34
Relay N.O./N.C. Status _____	36
Transmitter Security _____	37
Toggling Parameter Security On/Off (LK.ON) _____	37
Changing the Password (LK.PW) _____	37
Auto-Lock Timer (LK.tM) _____	37
Instrument Parameter Change Example _____	38
Sensor Self Test Option _____	39
Serial Communications	
Overview _____	42
Setting Up for Serial Communications _____	42
Modbus® RTU Protocol _____	44
Report Generation _____	49

Parameter Reference

Menus _____	52
The USER Menu _____	53
Alarm Relay Parameters _____	53
Sensor Parameters _____	55
The LOCK Menu _____	56
The COMM Menu _____	57
Loop Current Parameters _____	57
Report Generator Parameters _____	58
Serial Communication Parameters _____	60
The FACT Menu _____	62
Troubleshooting _____	65
Technical Specifications _____	66
Contacting SCOTT HEALTH & SAFETY _____	66
APPENDIX 1 - Modbus® Registers Addressing _____	66
APPENDIX 2 - (FSR) Command Functions _____	71
APPENDIX 3 - Modbus® Register Table _____	75
Record Your Parameters! _____	78
Warranty _____	79
Statement of Year 2000 Compliance _____	79
Spare Parts _____	80
Index _____	84

General Instrument Overview Map

Alphanumeric Display - Used for displaying decimal values in the range -999 to -0.00 and 0.000 to 9999, hexadecimal values in the range 0000 to FFFF, and text labels representing parameters during user setup.

Gas Concentration Units - Parameters can be set to display gas concentration in %V/V, PPM, and PPB.

Security Indicator (Lock) - Appears when software security is active, prohibiting parameter editing. When the security parameter is "locked" parameters may be reviewed, but not changed.

Alarm Indicators - Visible when alarm, fault, inhibit, or maintenance conditions exist.

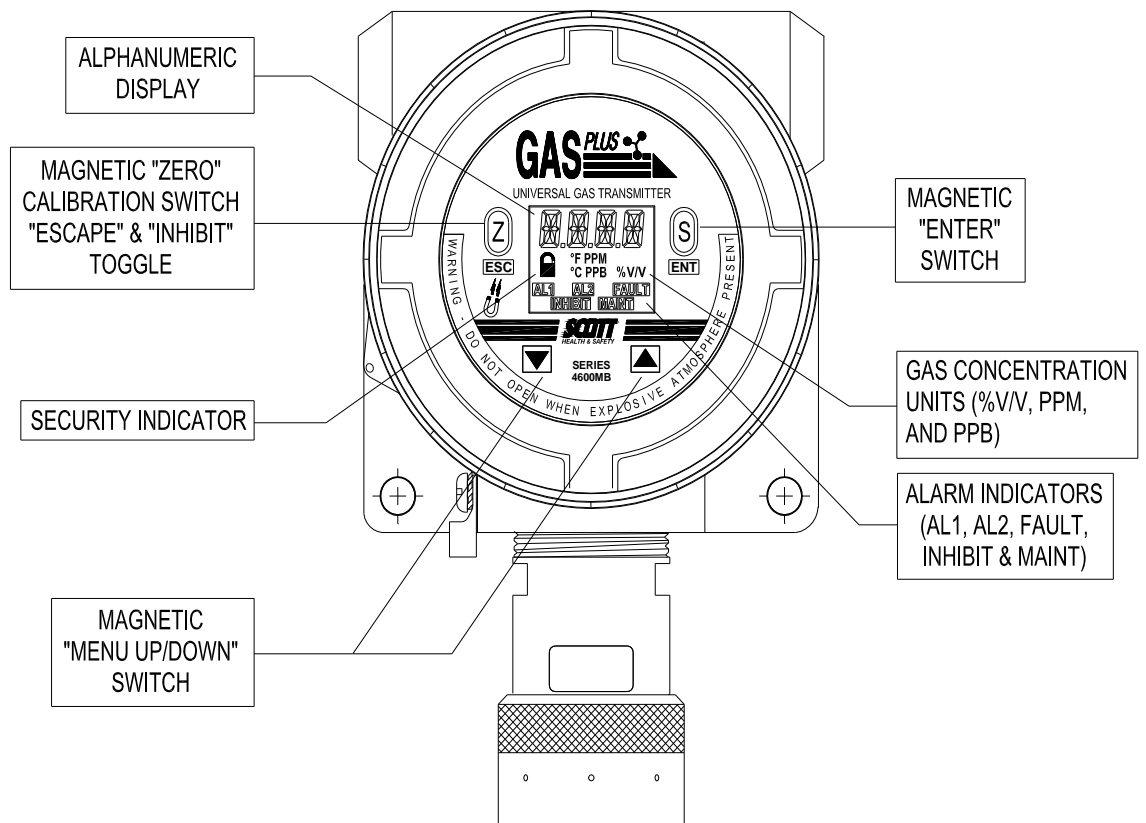

Figure 1 - Instrument Overview Map



Introduction

The 4600 GasPlus(MB) is a 24 VDC powered toxic gas transmitter and a microprocessor-controlled 4-20 mA device. It allows any of the Series 4600 toxic gas "smart" sensors (excluding the Model 88 combustible sensor) to be used for the detection of a specific target gas. When properly installed, non-intrusive operation of the transmitter and an intrinsically safe sensor permit the 4600 GasPlus(MB) to be operated and calibrated within potentially explosive environments without having to declassify such areas.

The 4600 GasPlus(MB) has been designed to provide many useful features required for such a device in today's industrial applications:

- Coated internal circuitry for protection against moisture and corrosion
- Three internal alarm relays (option)
- Selectable calibration inhibit levels
- Self diagnostics
- Modbus® RTU protocol

Scott Health & Safety Gas Sensor

Overview of Sensor Operation

Electrochemical gas sensors detect target gasses for which they were designed through a series of electrochemical reactions. Gas passes through a gas permeable membrane where it then contacts an electrolyte-saturated membrane. The gas is then oxidized or reduced (depending on the gas) at the sensing electrode, and the reaction is balanced at the counter electrode. In most sensors a third electrode acts as a reference to maintain a fixed potential at the sensing electrode. As gas concentration increases, a corresponding increase in current output occurs. The current output is measured, amplified, then converted by the transmitter to a signal on the 4-20 mA loop where it is used to read gas concentration.

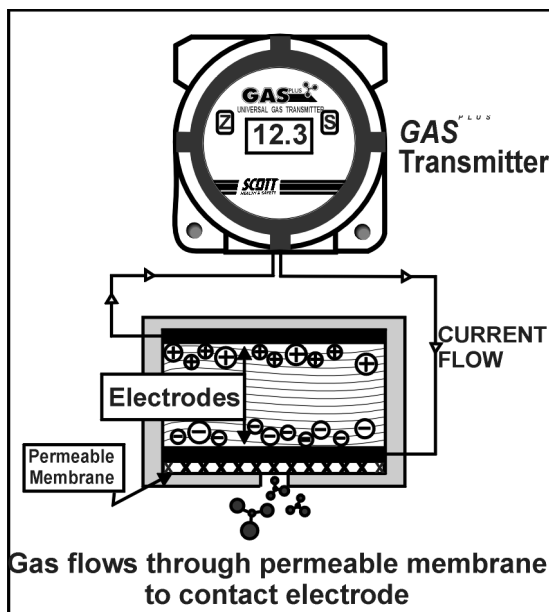

As gas concentration increases, a corresponding increase in current output occurs. The current output is measured, amplified, then converted by the transmitter to a signal on the 4-20 mA loop where it is used to read gas concentration.

The Sensor and Battery

Each "smart" sensor contains circuitry with an EEPROM and lithium battery. The EEPROM retains specific sensor data including gas measuring range, alarm setpoints, and sensor useful life value. When connected to the transmitter, the sensor data is uploaded to the transmitter. Upon disconnection of the sensor from the transmitter assembly, the bias potential (required by electrochemical sensors) across the sensor's electrodes will be maintained via the integral battery. The battery is capable of providing up to a total of 9 months of "off-line" power

(because the battery is not rechargeable, "off-line" time is cumulative), providing proper storage procedures are followed.

When storing the sensor "off-line", block the sensor gas hole by placing a small piece of electrical tape over the front of the sensor (**do not touch the membrane** as this will cause damage to the sensor) and store the sensor in a cool dry place (like a refrigerator).

Should the sensor be kept off-line for a *cumulative* period of time *exceeding 9 months, the sensor will continue to operate!* Sensor battery failure does not mean the sensor has failed and will not operate, only that it will require a 4-8 hour warm-up time upon installation. Once the sensor has "warmed-up" and has become stable, calibration may occur as normal.

Sensor battery failure does not render the sensor useless - but it will require a 4-8 hour warm-up time upon installation.

Gas Specificity

Each gas sensor is engineered and designed to be gas specific; however, the very nature of electrochemical gas detection is such that the presence of certain gases may act as an interferant to certain sensors. Each sensor can have its own interferant(s), causing the sensor to respond electrochemically.

Scott Health & Safety has tested and documented some of the known interferant. These values represent averages and will vary from sensor to sensor for a specific gas sensor. These are listed in an addendum located in the back of the manual.

Sensor Accuracy

The accuracy of a toxic gas sensing system is limited by the accuracy of the standard used to calibrate the system. For many toxic gases, obtaining a high accuracy standard that is suitable for field calibration use may be difficult (about the best accuracy of gas concentration achievable is 5%, using a permeation system with good temperature control). For this reason, no fixed accuracy statement is possible. The accuracy of the sensor cannot be better than the accuracy of the calibration gas. The best accuracy to be expected, assuming a perfect standard, is limited by the repeatability which is $\pm 2\%$ of span (full scale).

Sensor Response Times

Electrochemical gas sensors are optimized to give the fastest possible response time while maintaining excellent zero stability and minimum drift (approximate sensor response times are listed in an Addendum in the back of the manual). These response time values are an average. Each sensor has its own unique response time which may be slower or faster than the average. If the response time appears to be excessively slow, refer to the "*Weekly Operational Response Checks*" within the **TRANSMITTER OPERATION** section.

Sensor Life

Because applications are of such a variable nature, only experience on a given application can truly tell what the sensor life will be. The 4600 GasPlus(MB) sensors will generally provide a minimum of 12 months of service in ambient air gas detection applications. Extremes of humidity and temperature, and exposure to dirty atmospheres containing particulate matter or oily vapors will decrease sensor life. In addition, extended exposure to target or other active gases may shorten sensor life.

In applications where only trace levels of target gas exist, except under leak conditions, sensor life will most likely be over 18 months. While sensors may

have some, or even substantial life remaining, it is recommended that sensors be replaced at a convenient interval between 12 and 18 months. Experience in a given application or plant condition will determine the best replacement frequency.

Environmental Influences to the Sensor

Although the 4600 GasPlus(MB) transmitter is designed to operate at temperatures from -40° to 149°F (-40° to 65°C), the operating temperature is dictated by which gas sensor has been installed. **The "Gas Detection Capabilities" sheet (see back of manual)** shows the operating temperature ranges for each sensor type. Extreme temperatures and exposure to dirty atmospheres containing particulate matter or oily vapors can effect sensor response and decrease sensor life.

Humidity (%RH) has the potential to affect the performance of electrochemical sensors. Gas sensors are designed to provide stable output over a range of humidity conditions. Intermediate exposure to relative humidity conditions from 0% to 99% non-condensing RH (70% RH nominal) will not affect operation of most sensors.

Extremely dry air has the potential to adversely affect the operation of electrochemical sensors. At relative humidities continuously below 25%*, sensors can exhibit an early loss of sensitivity after a few days to a week of operation. This is caused by a slow loss of water from the internal sensor electrolyte. Suspending the sensor over a jar of water for 24 hours will usually restore sensitivity.

**The operation of H₂S and HCl sensors will be affected by continuous exposure to relative humidity conditions below 50%RH; therefore, Models 4654 and 4672 low humidity sensors, respectively, are offered and should be used when operating under these conditions.*

Extremely humid or wet conditions can affect these sensors which rely on an unobstructed gas diffusion path into the sensor. If the gas stream or ambient air allows humidity to condense on the sensor, the water on the membrane will cause loss of sensitivity, or slow response, or both. Once the sensor has had a chance to dry out, normal operation should be restored. If the source of moisture is a result of water spray or rain, a rain shield may be installed on the sensor module to protect the sensing membrane. Continuous exposure to high humidity will cause the sensor to oversaturate and will shorten sensor life. Normal ambient monitoring applications will not see a continuous high humidity. Keep in mind that the some gases may chemically react with water vapor and be converted to other species (e.g., ammonia hydrolyzes to form ammonium hydroxide when exposed to water vapor). In addition, other gases such as hydrogen fluoride are very reactive and may be absorbed on the inner surfaces of flow tubing before reaching the sensor during calibration. Such questions should be referred to chemists or industrial hygienists.

Sensor Oxygen Requirements

Gas sensors require a minimum of 5% oxygen for continuous operation under ambient conditions (except the Model 80 Oxygen sensor).

Sensors operating in conditions of less than 5% oxygen will provide erroneous or unstable concentration data.

Beyond the 5% minimum oxygen concentration requirement, all Hydride sensors (Arsine, Diborane, Germane, Hydrogen Selenide, Phosphine, Silane) require *constant* oxygen concentration when performing sensor calibration. Fluctuating oxygen concentrations during calibration will result in erroneous concentration readings during system operation.

Sensor Intrinsic Safety

An intrinsically safe circuit is simply defined as "...an electrical circuit which does not contain, or store, enough energy to cause ignition of a given explosive atmosphere". Sensors are designed as intrinsically safe and, with the transmitter incorporating built-in safety barrier circuitry, can be removed from the transmitter housing within explosive environments.

Sensor Handling and Disposal

Do not attempt to disassemble the sensor in any way. The sensor contains various chemicals/electrolytes. Skin and eye contact should be avoided and should be considered hazardous. The sensor can be disposed of as ordinary trash with no special precautions. Incineration in a municipal/commercial incinerator poses no hazard.

Installation

Location Considerations

Prior to installing the transmitter, consideration should be given to the following items when choosing its location:

*** Sensors**

Manufactured after October 2001 (S/N 1001-XXXX) can also be mounted horizontally. Do not mount on a 45 degree angle.

1. *** Orientation** - Always mount the sensor pointing downwards.
2. **Gas Density** - For gases heavier than air, the sensor is recommended to be installed approximately 18" from floor level. In these applications care should be taken to protect the sensors from physical damage. For gases that are lighter than air, sensors should be installed at a high level or close to the potential leak source.
3. **Potential Gas Sources** - The location and nature of potential vapor/gas sources (e.g., pressure, amount, source, temperature, and distance) need to be assessed.
4. **Ambient Temperature** - Insure that the system is located within an area that complies with the specified operating temperature range.
5. **Vibration** - Mount the transmitter and sensor in a manner that minimizes vibration.
6. **Accessibility** - When determining mounting location, consider future maintenance and calibration requirements.
7. **Avoid water.** Droplets adhering to the outer membrane of the sensor will reduce or negate sensor performance. A rain shield is recommended for outdoor installations.
8. **Avoid strong electromagnetic fields.** Mounting the gas transmitter near power transformers or other strong EM fields may cause undesirable results.
9. **Avoid pressure and excessive air velocity.** 4600 GasPlus sensors are designed to measure gas concentration under normal atmospheric conditions with up to 1 LPM air flow (only true with the flowcell). High air velocities will result in inaccurate measurement and reduce sensor life.
10. **Conduit Seals.** Protect the transmitter electronics from moisture by thoroughly sealing the conduit entries and tightening the cover of the transmitter housing.

Physical Installation and Wiring

Installation of the transmitter requires the physical mounting of the enclosure (see Figures 1-3) and connection of the power/output lines (see Figures 4-7). The transmitter enclosure is provided with bolt holes in the mounting flange for mounting. Follow these steps after first ensuring that the area of installation is declassified if required:

- STEP 1** - Make all physical connections (i.e., conduits, pipes, enclosure, plastic spacer block, junction box, etc.)
- STEP 2** - Unscrew transmitter cover and turn power switch to the "OFF" position.
- STEP 3** - Grasp the top display board, and pull outward while gently rocking it from top to bottom. Both the top display board and the center CPU board will remove, exposing the electrical connectors on the Power

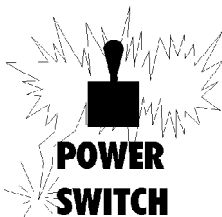

Place in the OFF position before removing Display / CPU board stack. Ensure power switch is in the OFF position prior to replacing board stack.

Supply board in the bottom of the housing. The terminal blocks pull out for easy access. Be sure power switch is in the "OFF" position. The power switch is located on the display board.

- STEP 4** - Make wire connections (16 to 22 AWG wire is recommended for electrical connections) in accordance with **Figures 4-7** as applicable. Ensure that proper wire gauge is used and that all wire, electrical grounds, and sensor connections are secure and intact.
- STEP 5** - Replace transmitter stack assembly and return power switch to "ON".
- STEP 6** - Screw transmitter cover on, ensuring a tight seal.
- STEP 7** - Remove red label from the bottom of the sensor end cap.

Remote Sensor Junction Box Mounting

If the application requires that the sensor be mounted remote from the transmitter, care should be taken to insure that all code and regulatory requirements are met. In these applications, it is recommended that the sensor be separated from the transmitter **no more than 50'**. Additional items needed will be a junction box and sensor cable (**see Figure 8**). These items can be ordered from the factory. Conduit must be obtained from your local vendor.

Maximum Wire Length

AWG wire size requirements are dependent upon power supply voltage and wire length.

The maximum distance between the transmitter and its power supply is determined by the maximum allowable interconnecting loop-voltage drop. If the voltage drop is exceeded, the transmitter will not operate. To determine the maximum loop-voltage drop, subtract the transmitter's minimum operating voltage (18 VDC) from the power supply's minimum output voltage. For example; if the power supply's minimum output voltage is 24 VDC, then the maximum voltage drop across the power supply is 6 volts.

To determine actual maximum wire length, divide the maximum allowable voltage drop by the transmitter's maximum current draw, then by the resistance of the wire (ohms/foot), then divide by 2.

Stand-Alone 24 VDC Power Supply	
V _{MIN} Source Voltage	24 VDC
V _{MIN} Transmitter	18 VDC
I _{MAX} Transmitter	50 mA w/relays 100 mA w/o relays
R _{MAX} of Wire	24 Ohms
Wire Ohms/ft	Max Length Ft (M)
18 AWG (0.00639 Ohm/ft)	1878 (572)
20 AWG (0.01015 Ohm/ft)	1182 (360)
22 AWG (0.01614 Ohm/ft)	743 (227)

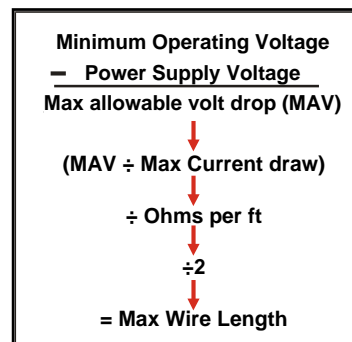

Switches and Circuit Breakers: UL and EN Requirements

EN 61010-1, 1995 edition and UL 3111-1, 1994 edition (Safety Requirements for Electrical Equipment for Measurement, Control and Laboratory Use - Part 1: General Requirements) contain the following requirement:

Except as specified in 6.12.1.1, equipment shall be provided with a means for disconnecting it from each operating energy supply source, whether external or internal to the equipment. The disconnecting means shall disconnect all current-carrying conductors.

For the transmitter to comply with EN 61010-1, 1995 edition and UL 3111-1, 1994 edition:

1. A switch or circuit breaker must be included in the 4600 GasPlus(MB) installation,
2. The switch or circuit breaker must be in close proximity to the equipment and within easy reach of the operator, and
3. The switch or circuit breaker must be marked as the disconnecting device for the transmitter.

Current Sourcing and Sinking Modes

The transmitter may be wired in a current sourcing or a current sinking mode. As the names suggest, these 2 modes describe the direction of current flow in the 4-20 mA loop connecting the 4600 MB transmitter and its receiver. Principally, this is dictated by which end of the loop is connected to the positive supply voltage (the source).

Current sourcing mode. When the transmitter is wired in current sourcing mode, a positive voltage supply is connected to the transmitter's mA+ terminal [TB1-3]. Note that this may be the same supply powering the instrument or a different one (see **Isolated and Non-Isolated Loop Power**). Current flows into the mA terminal [TB1-3] and out of the mA- terminal [TB1-4], controlled by the virtual resistance of the instrument. From the transmitter's mA- terminal [TB1-4], current flows into the receiver's + terminal, and then out of the receiver's - terminal to the power supply negative (common).

Current sinking mode. When the transmitter is wired in the current sinking mode, the positive supply voltage is connected to the receiver's + terminal. Note that this may be the same supply powering the instrument or a different one (see **Isolated and Non-Isolated Loop Power**). Current flows through the receiver and out of the - terminal to the transmitter's mA+ terminal [TB1-3]. Controlled by the virtual resistance of the instrument, current flows out of the transmitter's mA- terminal [TB1-4] to the supply negative (common).

Isolated and Non-Isolated Loop Power

When the current loop power supply is different than the one used to power the transmitter, the loop is "isolated." When the same power supply is used for both the current supply and the instrument, the loop is "non-isolated." Many PLCs require an isolated loop.

The transmitter can be wired with either isolated or non-isolated power. Note from **Figures 4B/D** that isolated power requires 4 wires, whereas non-isolated power can use a 3-wire configuration.

Powering The Transmitter

When power is applied to the transmitter, all segments and indicators on the display will turn on for 2 seconds, then will turn off for 2 seconds. The transmitter will subsequently enter a 30 second warmup period (countdown shown on the display).

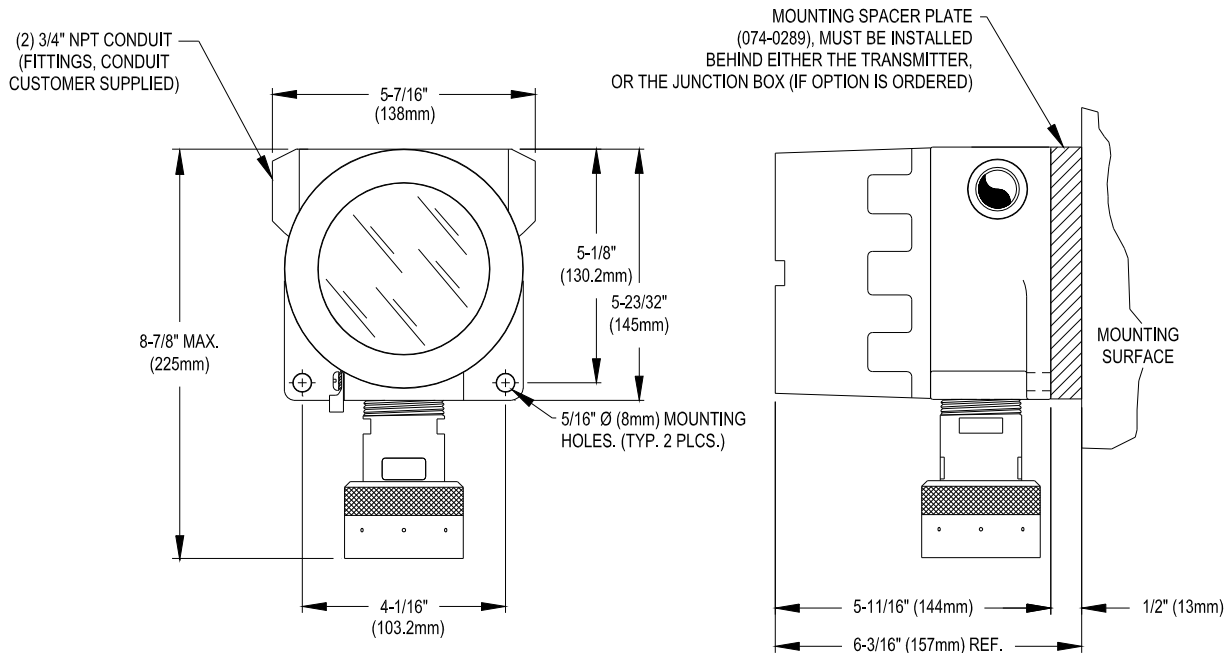

Figure 1 - GasPlus Dimensions

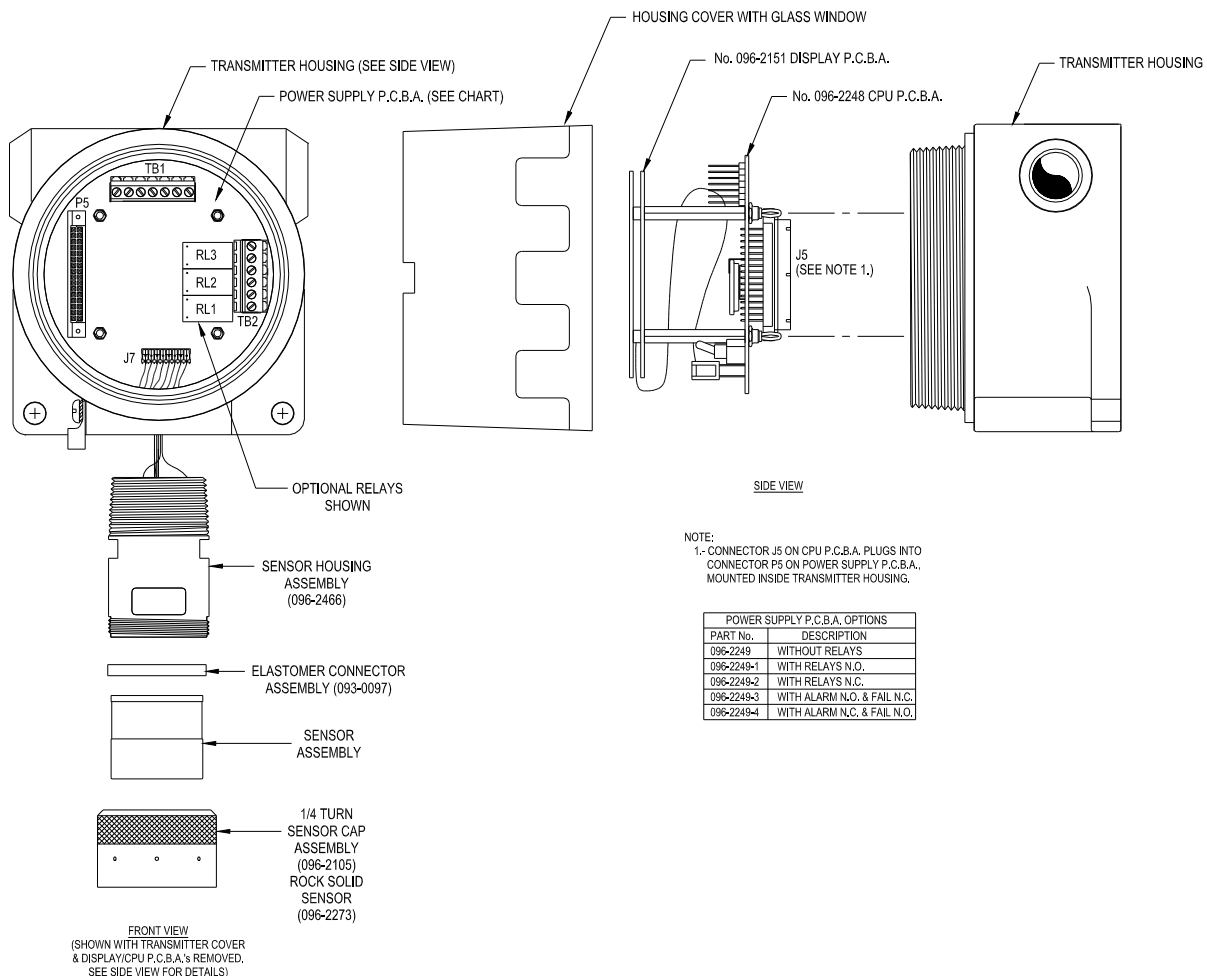

Figure 2 - GasPlus Assembly

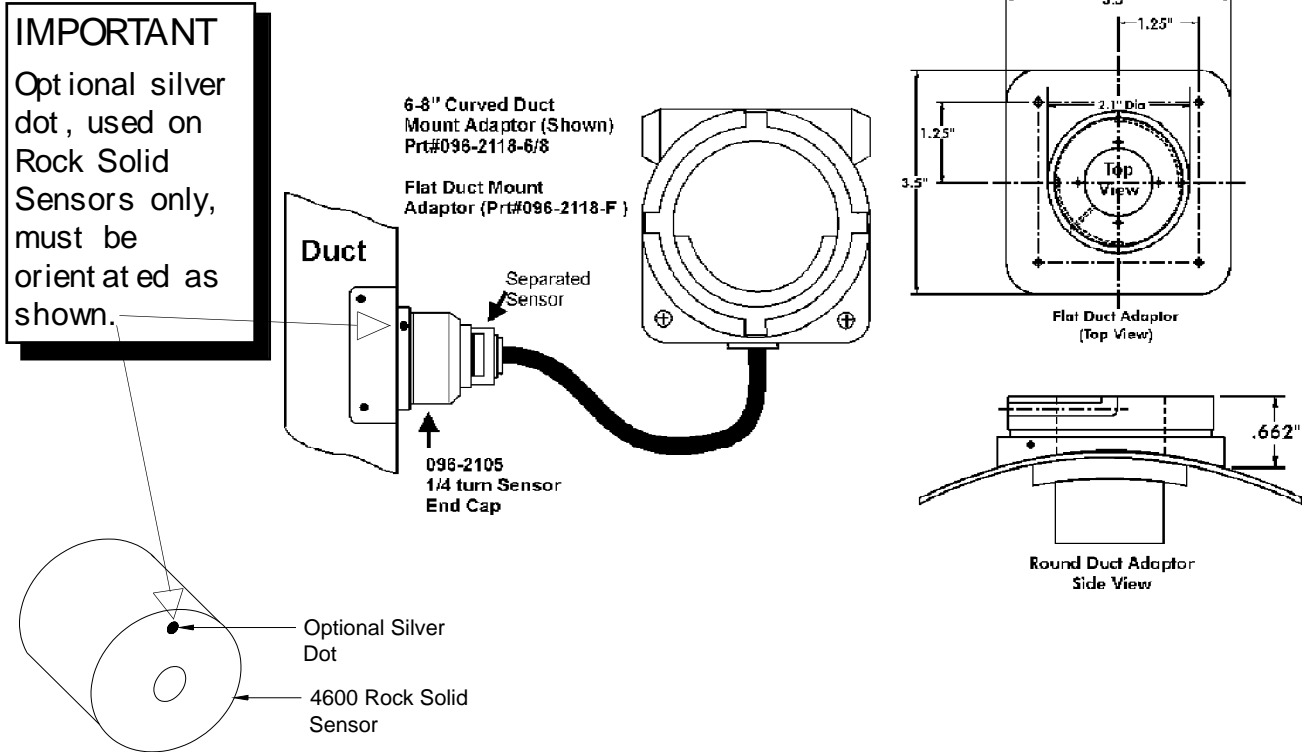

Figure 3 - Optional Duct Mount Installation

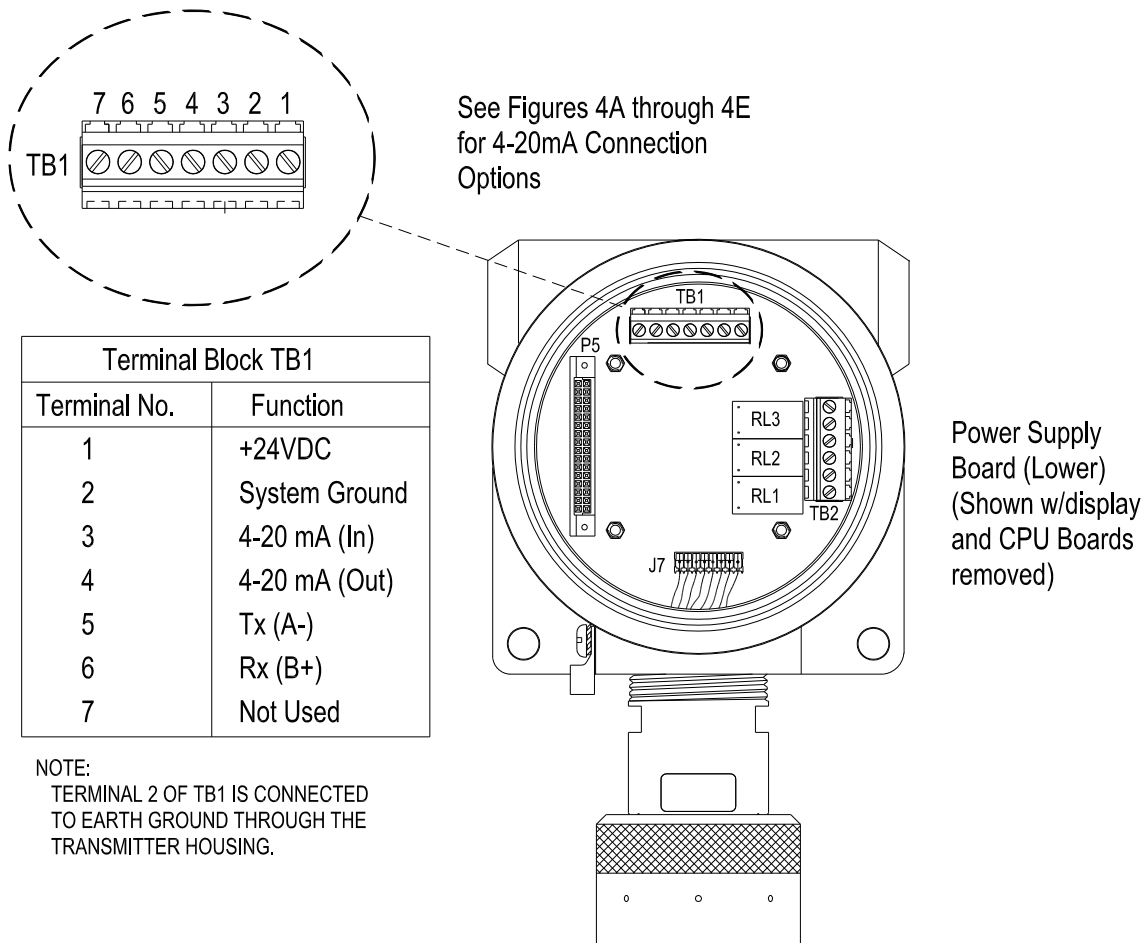

Figure 4 - 4-20 Current Loop Connections

Current Source with Non-Isolated Loop Power

POWER SWITCH
Place in the OFF position before removing Display / CPU board stack. Ensure power switch is in the OFF position prior to replacing board stack.

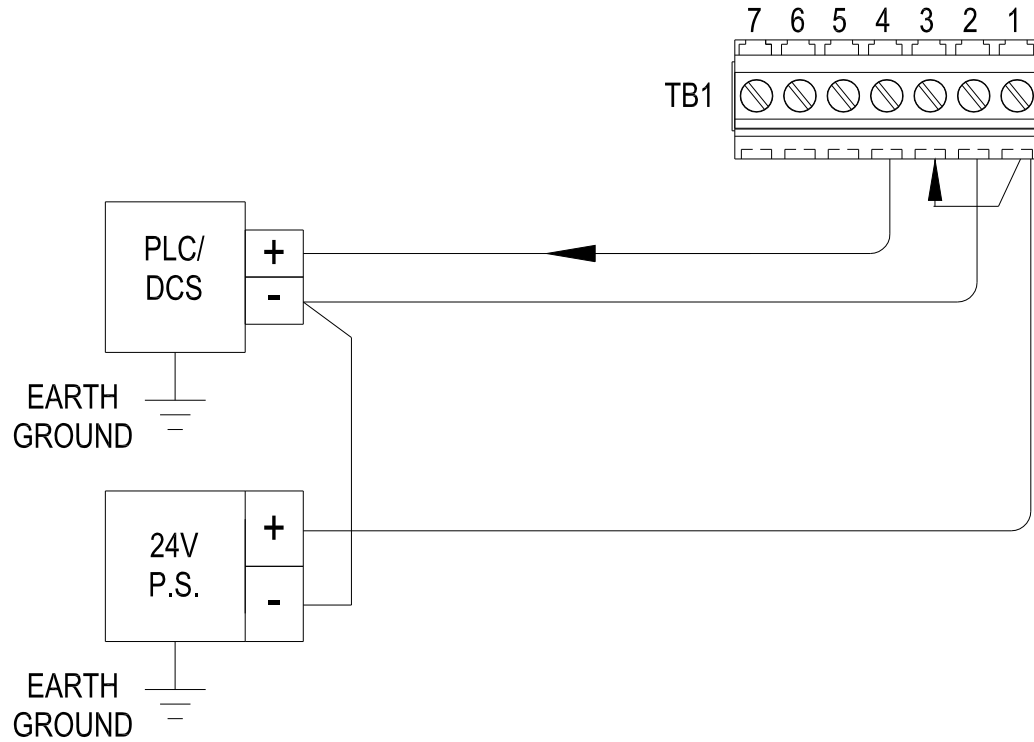

Figure 4A - Alternate 4-20 mA Current Loop Connections

Current Source with Isolated Loop Power

POWER SWITCH
Place in the OFF position before removing Display / CPU board stack. Ensure power switch is in the OFF position prior to replacing board stack.

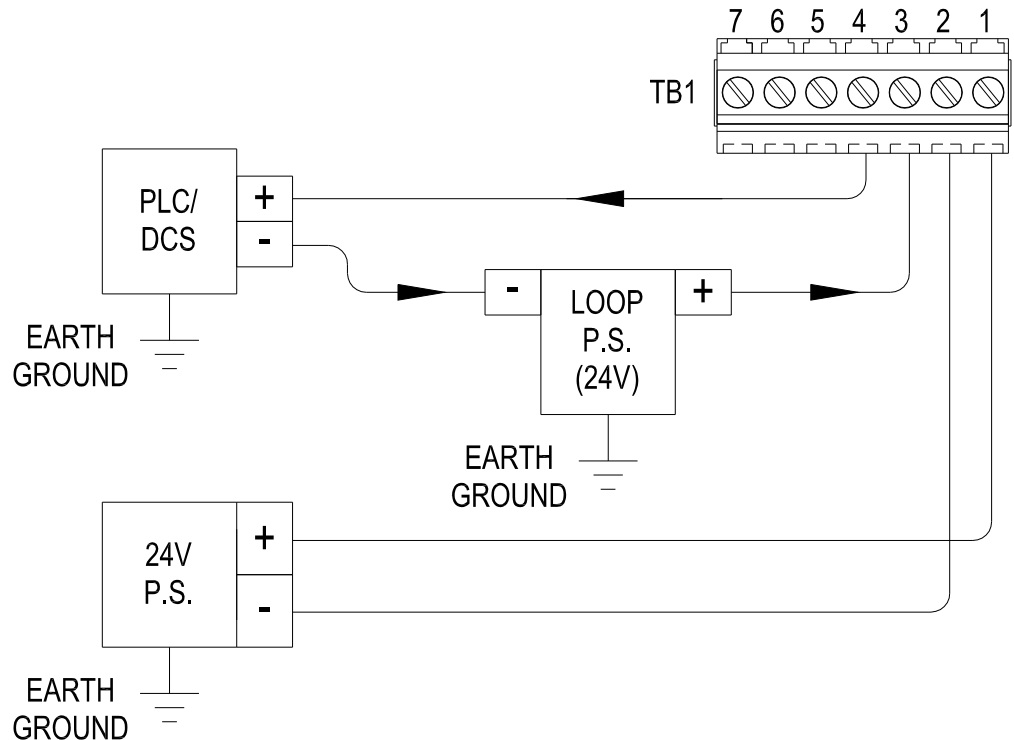
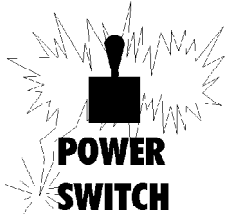

Figure 4B - 4-20 mA Current Loop Connections



POWER SWITCH
Place in the OFF position before removing Display / CPU board stack. Ensure power switch is in the OFF position prior to replacing board stack.

Current Sink with Non-Isolated Loop Power

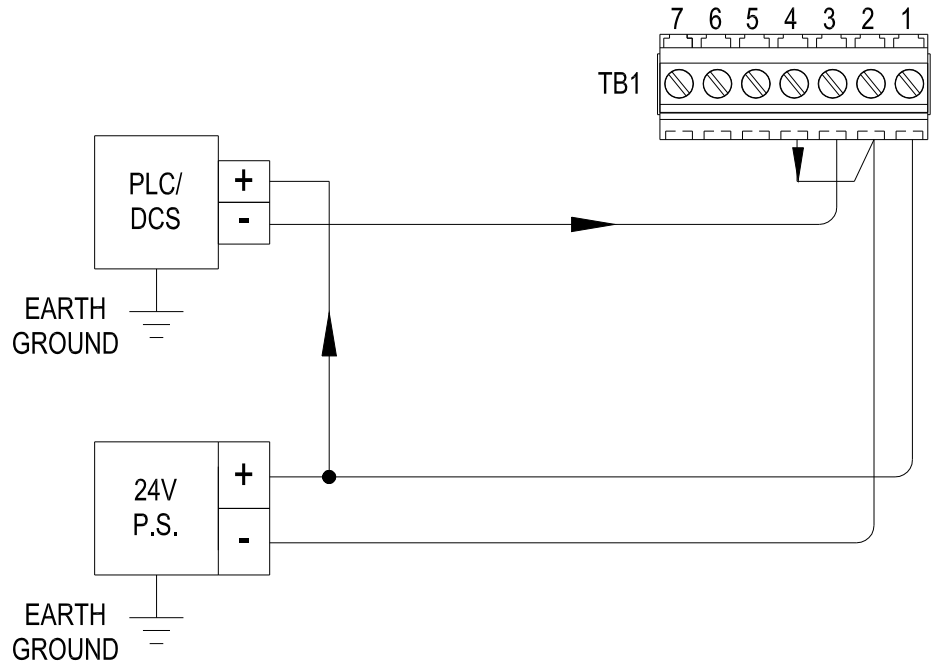
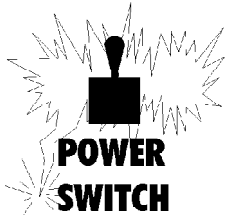

Figure 4C - Alternate 4-20 mA Current Loop Connections



POWER SWITCH
Place in the OFF position before removing Display / CPU board stack. Ensure power switch is in the OFF position prior to replacing board stack.

Current Sink with Isolated Loop Power

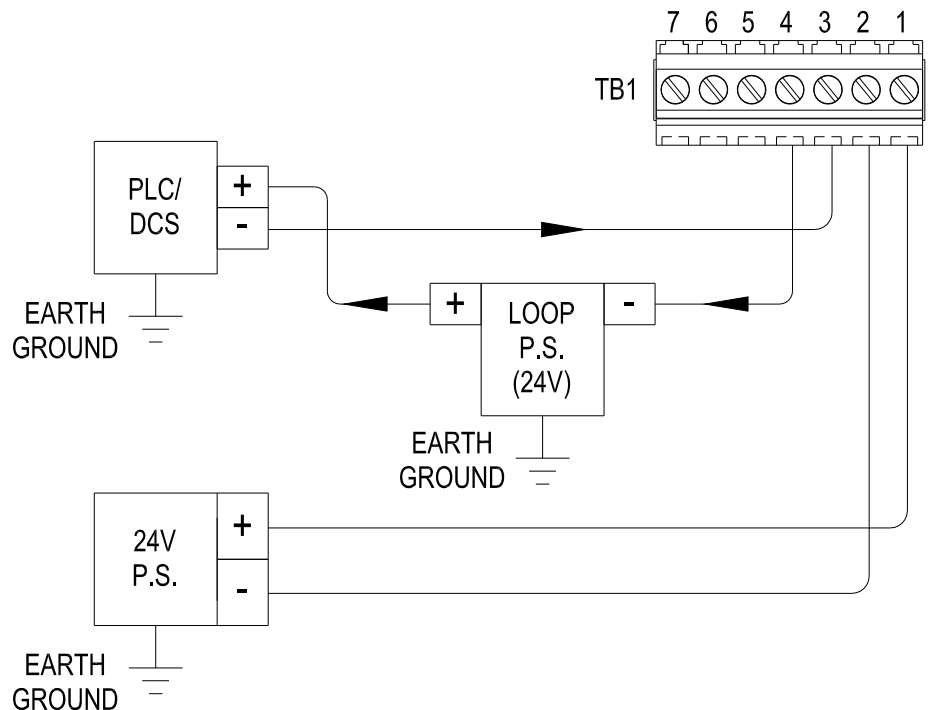
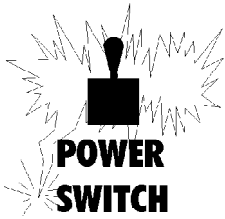

Figure 4D - Alternate 4-20 mA Current Loop Connections

Required Connections When Not Using Current Loop Output



Place in the OFF position before removing Display / CPU board stack. Ensure power switch is in the OFF position prior to replacing board stack.

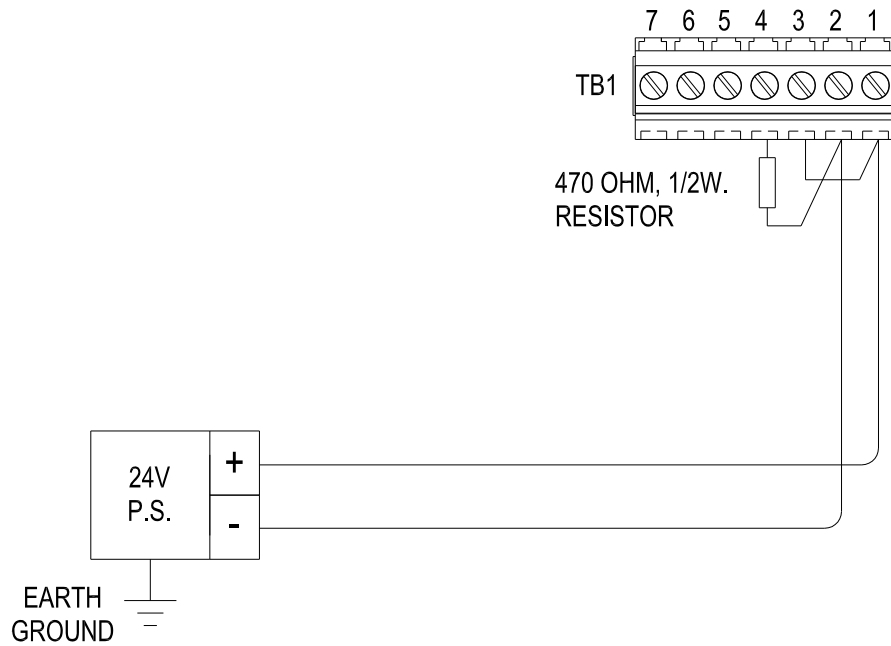
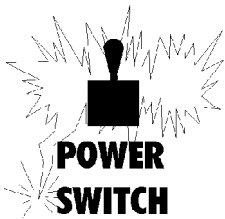

Figure 4E - Alternate 4-20 mA Connections



Place in the OFF position before removing Display / CPU board stack. Ensure power switch is in the OFF position prior to replacing board stack.

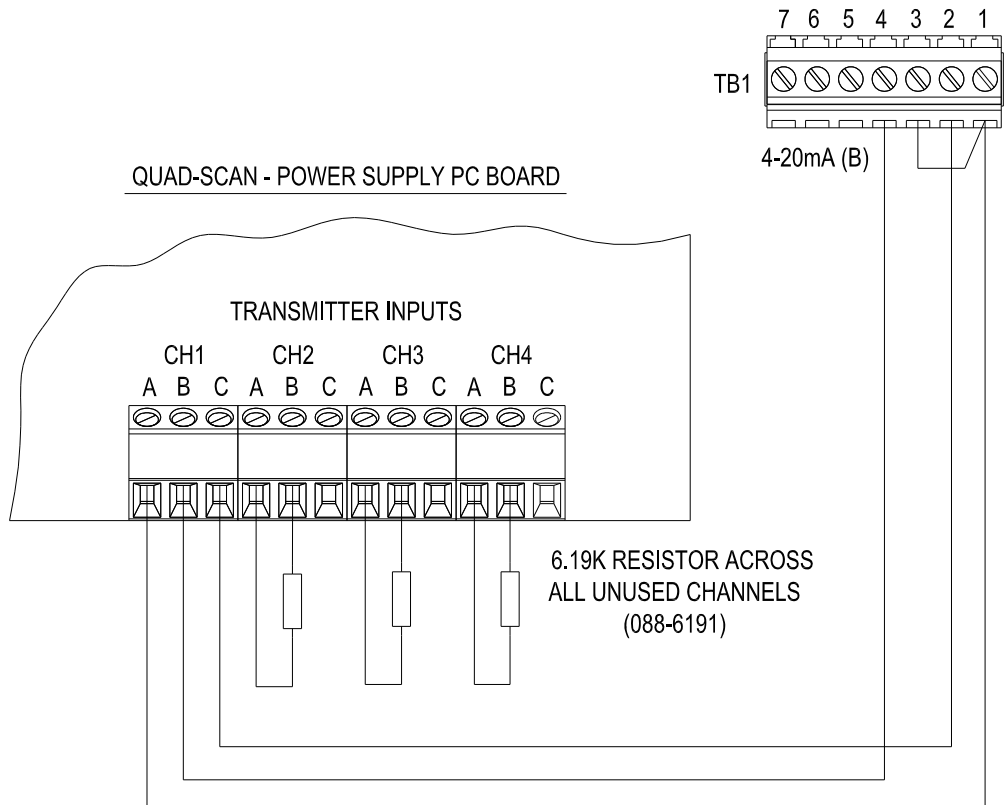
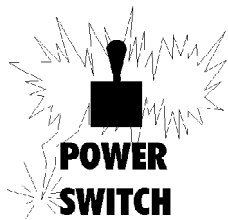

Figure 4F - Connection to 6004/6104 Quad-Scan



POWER SWITCH
Place in the OFF position before removing Display / CPU board stack. Ensure power switch is in the OFF position prior to replacing board stack.

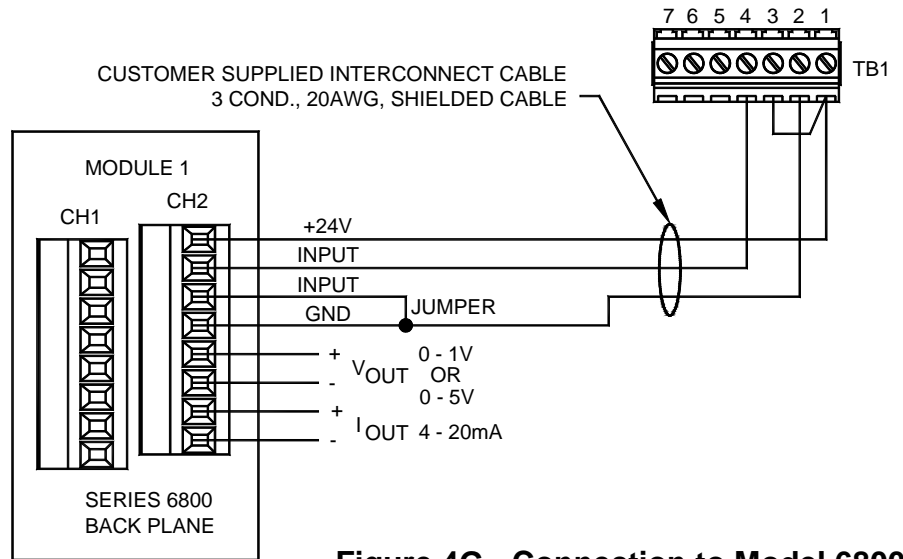
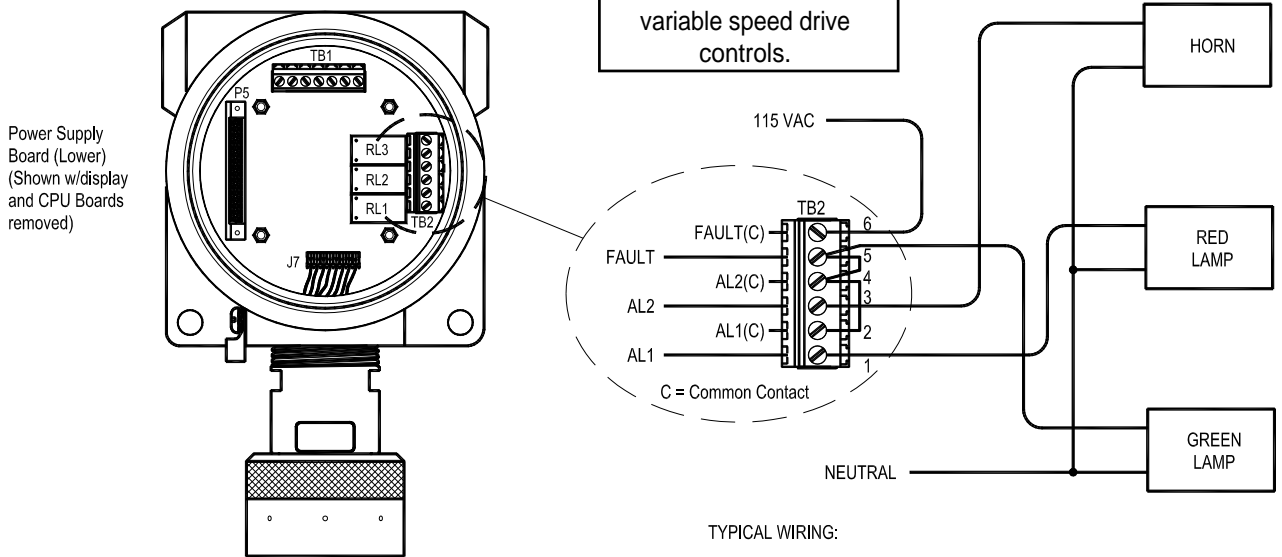

Figure 4G - Connection to Model 6800

! EMI/RFI ALERT !
When installing transmitters equipped with internal relays, all power lines should be shielded. The best practice is to run relay power wiring in separate conduit from DC power wiring and away from other 110VAC power lines or sources of EMI/RFI such as variable speed drive controls.



Power Supply Board (Lower) (Shown w/display and CPU Boards removed)

RELAYS CAN BE EITHER NORMALLY OPEN OR NORMALLY CLOSED, BUT ARE CONFIGURED AT FACTORY PRIOR TO SHIPMENT

TYPICAL WIRING:

HORN SOUNDS ON HIGH ALARM.
RED LAMP LIGHTS ON LOW ALARM.

GREEN LAMP LIT UNDER NORMAL CONDITIONS OFF DURING FAULT, OR POWER FAILURE AND PREVENTS FALSE ALARMS. (TRANSMITTER KEEPS FAULT RELAY ENERGIZED UNDER NORMAL CONDITIONS.)

NOTE: Normally open/normally closed status assumes the concentration relays are programmed as non-failsafe and the fail relay as fail safe.

Figure 5 - Alarm Wiring

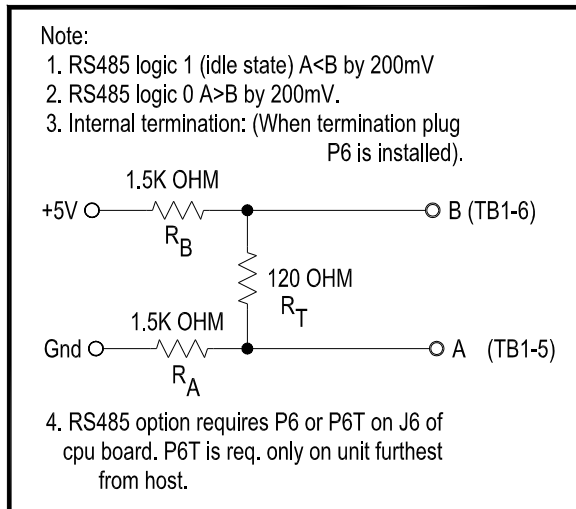
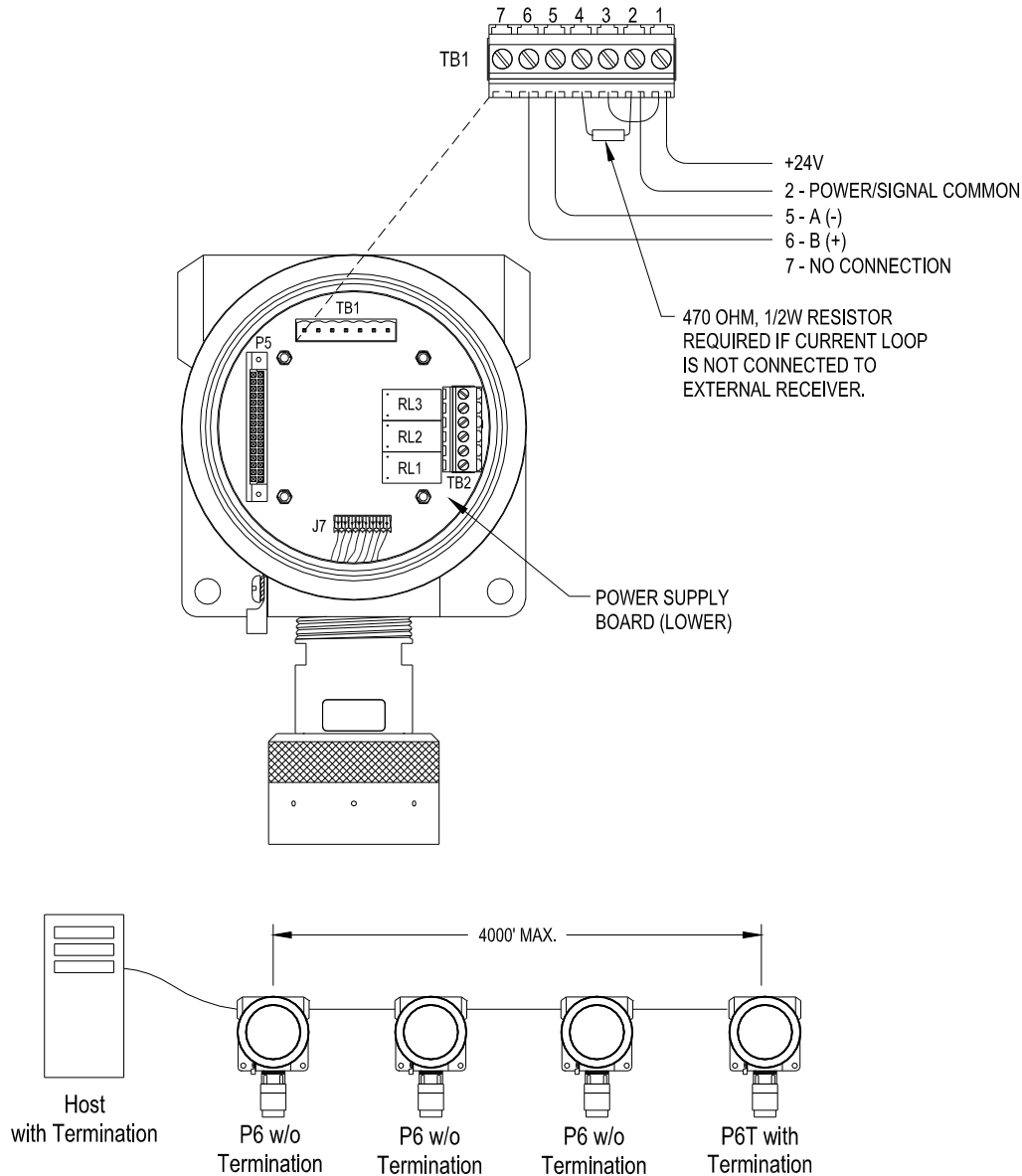

Figure 6 - RS-485 Wiring & Configuration

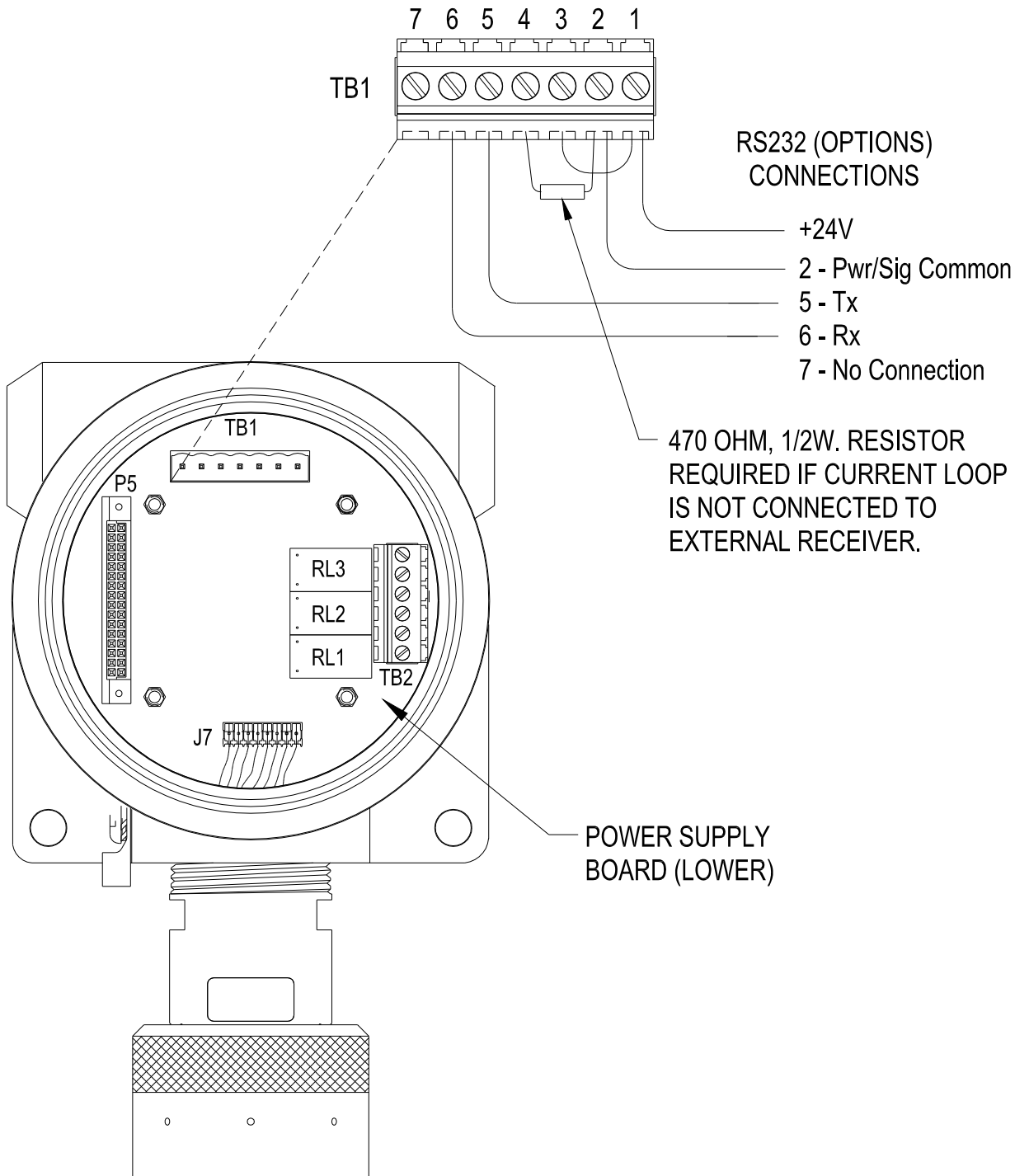

Figure 7 - RS-232 Wiring & Configuration

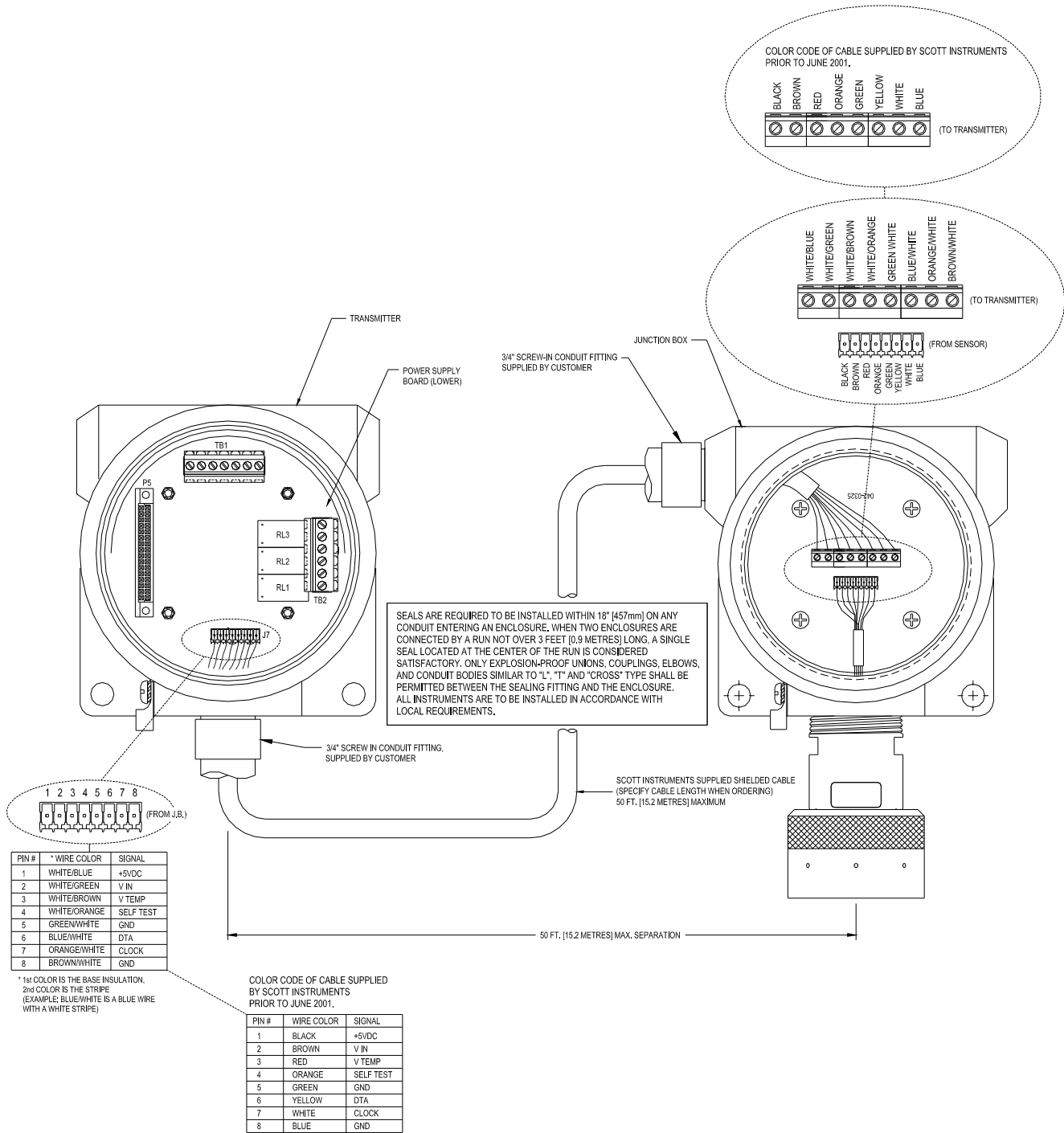

Figure 8 - Junction Box Electrical Installation

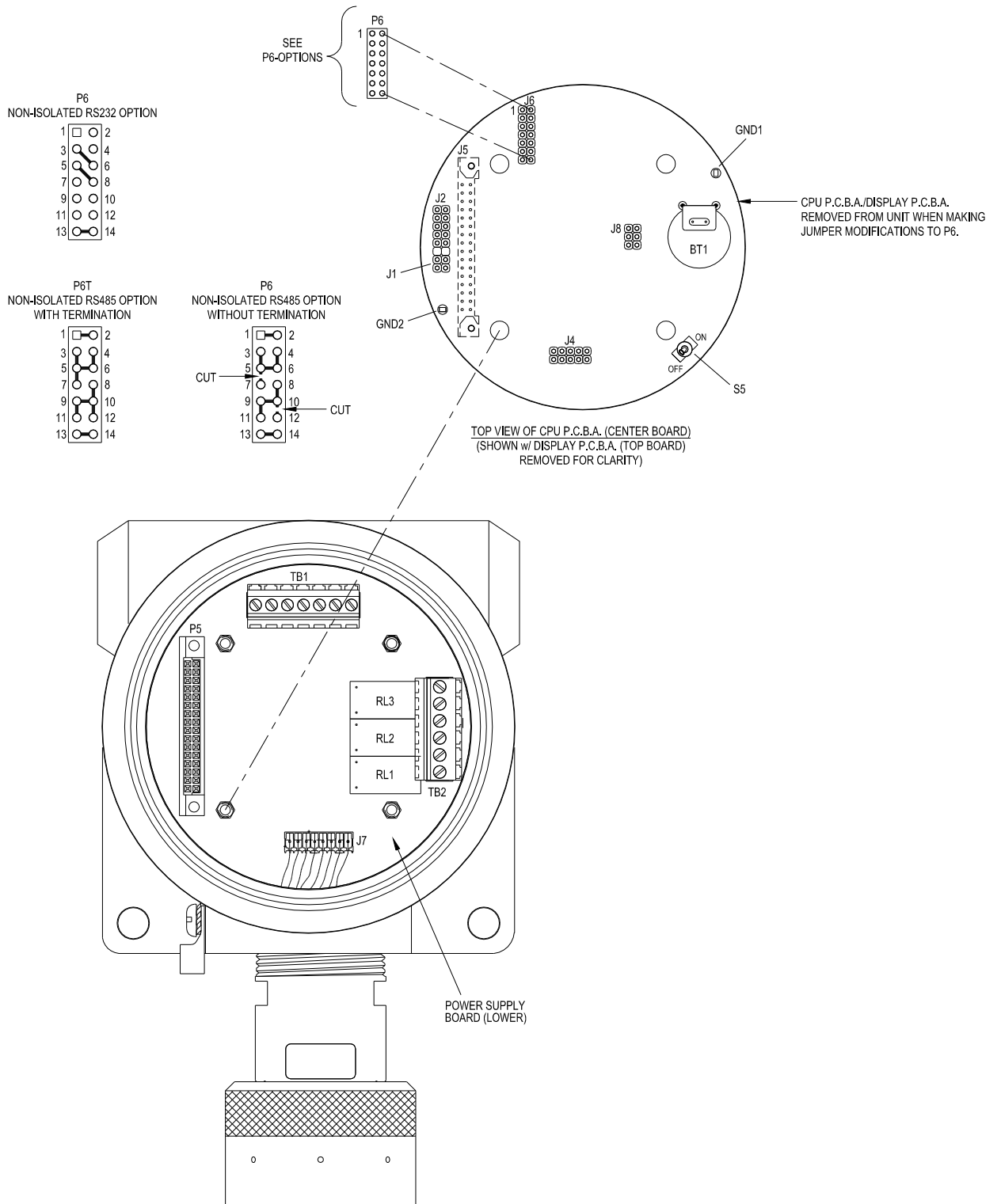
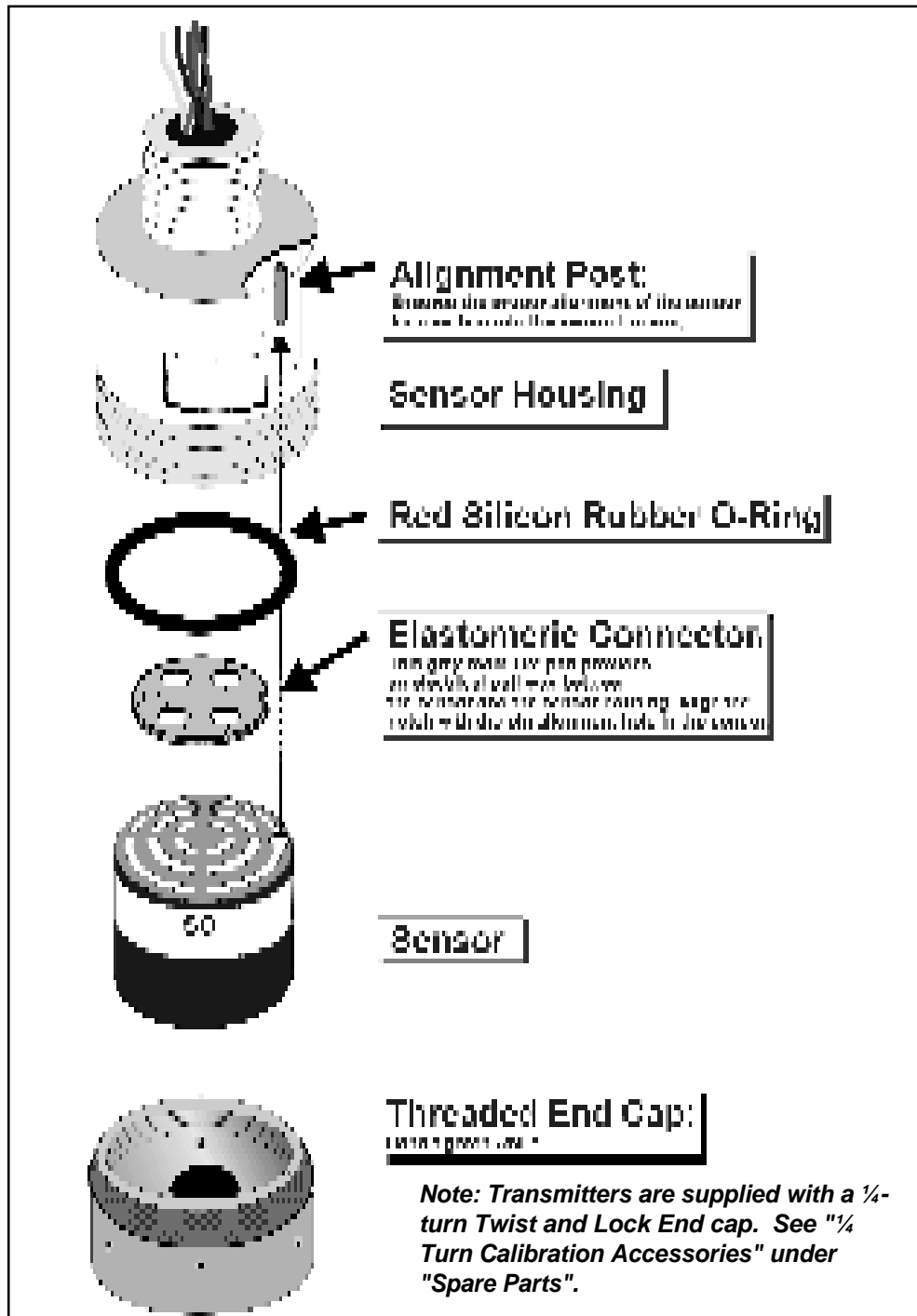

Figure 9 - RS-232/RS-485 Connections



! IMPORTANT !
The sensor should always be facing downward. Sensors manufactured after October 2001 (S/N 1001-XXXX) may also be mounted horizontally. Sensors should never point at any angle.

Figure 10 - Installing The GasPlus Sensor

Sensor Installation

Figure 10 depicts the 4600 GasPlus sensor installation. Be sure to include the elastomeric connection pad when installing the sensor into the sensor housing. Rotate the sensor until it locks into the alignment pin. The gas name/range will be visible through the housing front. To ensure proper connection between the sensor and the sensor housing, tighten the threaded sensor end cap hand tight - **do not over-tighten as this could damage the elastomeric connector or the sensor housing!**

Twist and Lock Accessories

Designed for quick, easy installation and removal from your 4600 GasPlus(MB) Transmitter, Twist-and-Lock accessories connect directly to the standard end cap and help make your gas detection system easier to use.

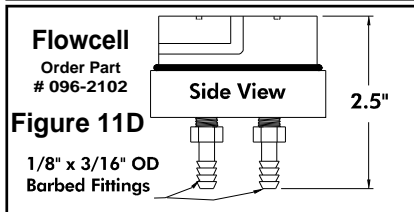
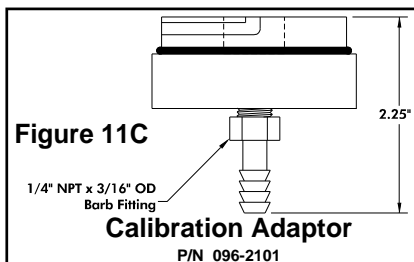
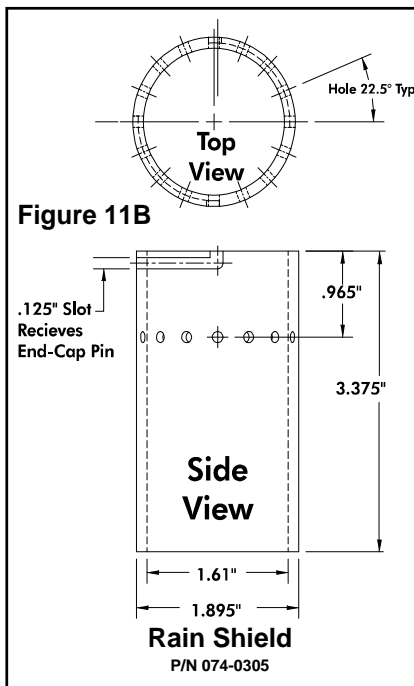
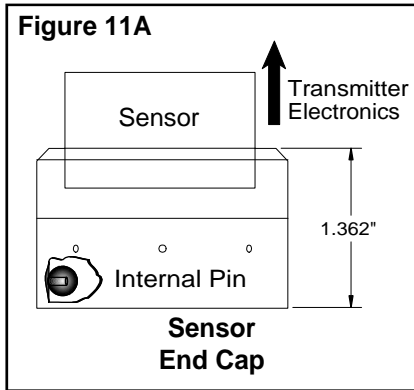

Rain Shield/Splash Guard (Part #074-0305)

Provides protection from wet weather and hose-downs. Teflon® construction permits use with both reactive (such as hydrogen fluoride, hydrogen chloride, and ammonia) and non-reactive gases. Lab tested hole geometry protects sensors from stray water droplets.

Calibration Adaptor (Part # 096-2101)

Deliver calibration gas directly to the sensor face without dilution from environmental interferences such as wind. Barb fitting provided for tube connection to the calibration gas source (gas cylinder, permeation device, generator).

Duct-Mount Adaptor

(Part # 096-2118-6/8 [6" to 8" Duct] or #096-2118-F [Flat Duct])

Monitor airflow in exhaust or ventilation ducts without drying out your sensor. Able to handle flow velocities from 350 to 1000 fpm. Available for use on flat ducts or 6" to 8" diameter ducts (custom sizes also available). *For use only with transmitters configured for remote sensor and without junction-box.*

Flowcell (Part # 096-2102)

Designed for sample draw configurations.

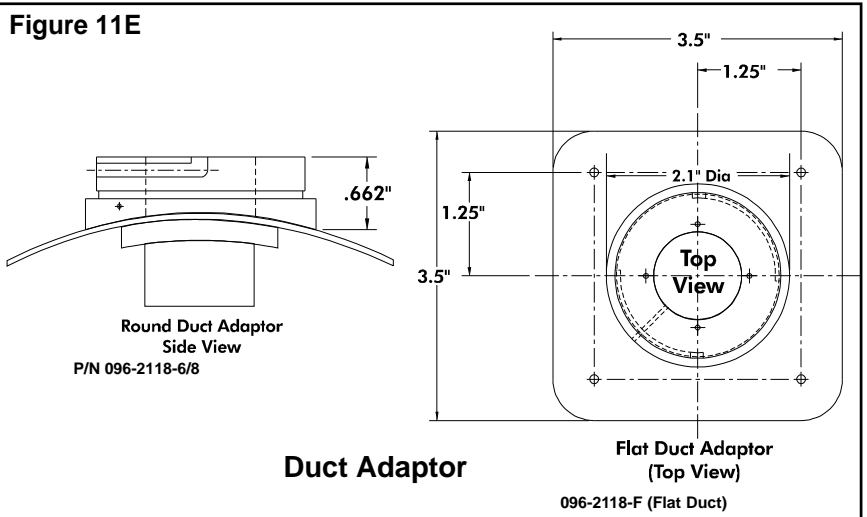

Transmitter Operation

Navigating the Instrument

All adjustments on the **4600 GasPlus(MB)** are made non-intrusively through the front panel of the instrument with a magnetic screwdriver. A "Parameter Navigation Map" is also provided at the beginning of the "Technical Reference" section. Four keys are used for all settings:



Referred to as the Z/ESC key. Used to zero the instrument and place unit into inhibit. Also used to abort an adjustment and/or back up to the previous menu.



Referred to as the S/ENT key. Used to span the instrument and select a menu option or to enter a setting.



Referred to as either the "Down" and "Up" arrow keys. Used to move up or down through a menu or to increase/decrease a setting.

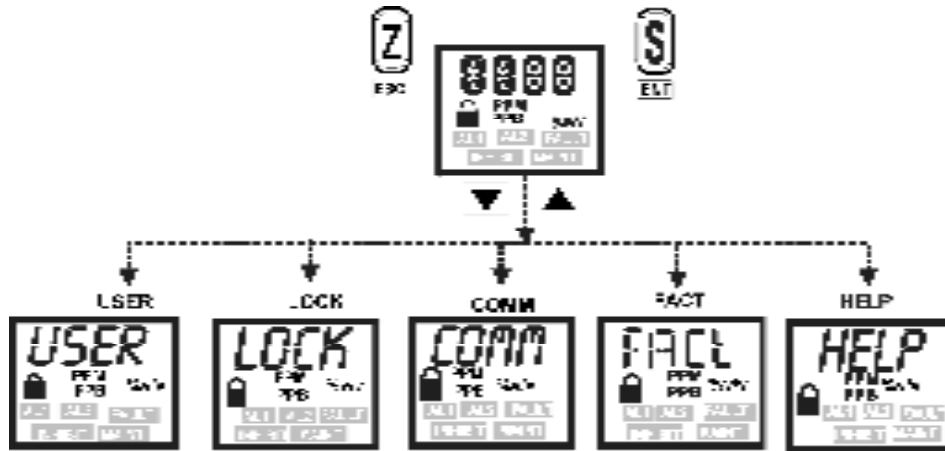



RUN Mode

The transmitter's normal operating mode is referred to as "RUN mode". The transmitter will always return to RUN mode if no keys have been activated for 2 minutes. In RUN mode, the LCD's alphanumeric display will show the ambient gas concentrations or a fault code (if a problem exists with the instrument)

How to Adjust Transmitter Parameters

Parameters are located in 5 main menu groups:

- **USER (Alarm and Sensor Parameters)**
- **LOCK (Security)**
- **COMM (Communications)**
- **FACT (Factory)**
- **HELP (Scrolling help message on each parameter)**











From RUN mode, the user can access the menus by touching the magnet to the  (Up) or  (Down) arrow key then selecting the S/ENT key. The Z/ESC key is used to back out of the menu and return to RUN mode.



The instrument continues to sense gas and transmit a signal when it is not in RUN mode.

Each menu contains a set of logically grouped parameters. After a menu has been selected, the first parameter in the menu is displayed on the LCD. For example, if the USER menu is selected, A1.SP (alarm setpoint 1) will be shown on the display. The user can scroll through the parameter list by touching the magnet to either the Up or Down arrow keys.



STEP 1	 	Scroll through menus.
STEP 2		Access the selected menu.
STEP 3	 	Scroll through the menu's parameters.
STEP 4		Access the selected parameter.
STEP 5	 	Scroll to select parameter value.
STEP 6		Store the selected parameter value. Verify "SEt" is displayed.
STEP 7		Return to the previous menu level (3x returns to the main display).

A form is provided in the back of this manual to record your transmitter's parameter set up.

Touching the magnet to the S/ENT key while the parameter is displayed (selecting the parameter) causes its value to be displayed for editing. Editing is done by placing the magnet over the Up and Down arrow key to increment or decrement its value, and then placing the magnet on the S/ENT key to store the new value. The display changes to "SEt" if successful, or "ERR" if a memory or other error is detected.

Acknowledging Latched Alarms

Latched alarms may be reset only after conditions have returned to normal (concentration is below the alarm reset point). To reset a latched alarm, momentarily apply the magnet to any key. Observe that the specific alarm indication has cleared from the main display.

Inhibiting Output

The 4600 GasPlus(MB) transmitter's INHIBIT function prevents activation of alarm relays in addition to holding loop output at the programmed inhibit level. *NOTE: Alarms are inhibited automatically at power on (for 30 seconds).* When INHIBIT is toggled ON, it will automatically toggle OFF after 9 minutes unless a key is activated. The inhibit time-out period is reinitialized after touching any of the 4 keys with the magnet. To activate the inhibit function,



place the magnet over the Z/ESC key for 2 seconds, then remove. Observe the LCD displays **INHIBIT**. The inhibit mode can be toggled OFF by again reapplying the magnet over the Z/ESC key for 2 seconds, then removing. The period may be reprogrammed by changing the value of the **AL.IP** parameter in the **USER** menu.

Calibration Frequency

All GasPlus transmitters require calibration upon receipt from the factory, after which the calibration interval for each transmitter should be independently established through a documented procedure which maintains a calibration log. Calibration frequencies will vary depending upon individual applications. Harsh environments will generally require more frequent calibration.

At a minimum, the following calibration frequencies are recommended:

Zero Calibration: Upon system power-up or sensor installation, not to exceed 30 days. **Oxygen Transmitter exception - every 90 days.**

Span Calibration: Upon system power-up (unless sensor has been pre-calibrated); every 90 days or less. **Oxygen Transmitter exception - every 30 days.**

Calibration Reminder...

- **Document your calibration schedule requirements.**
- **Maintain an organized system to prevent confusion between calibrated and un-calibrated sensors.**
- **Properly store all spare sensors.**

Contact the sales or service departments at the factory to learn more about the CAL PLUS calibration service.

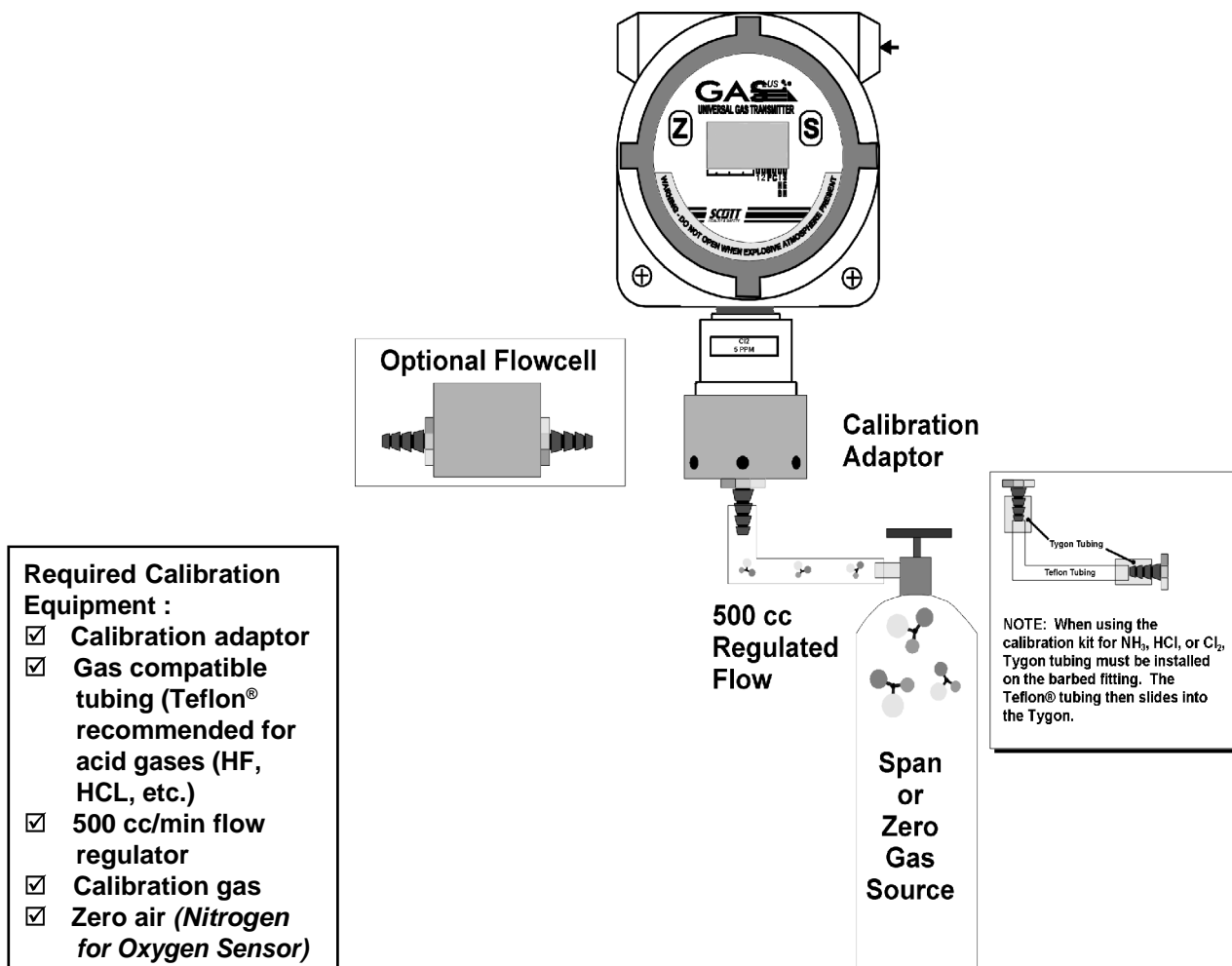

Figure 12 - Calibration Equipment

Remote Sensor Calibration

The 4600 GasPlus(MB) transmitter is designed so that the sensor may be removed and calibrated at a remote location. Fixed gas detection installations using this feature should utilize a documented calibration log (see "*Calibration Frequency*") to determine sensor rotation schedules. In addition, spare sensor(s) will be required so that continuous monitoring of the detection point is assured and a spare "powered" transmitter will be required to conduct the calibration at a remote site. Prevent accidental installation of uncalibrated sensors by marking all calibrated sensors with their last calibration date or maintain them in an otherwise appropriate manner.

To remove and replace the 4600 GasPlus sensor:

- STEP 1** - Inhibit the transmitter alarms and 4-20 mA output by momentarily placing the magnet over the Z/ESC key. Observe the LCD indicates INHIBIT.
- STEP 2** - Unscrew the sensor end cap and remove the sensor requiring calibration. Note that the fault alarm relay is unaffected and the current loop output remains at the programmed inhibit level.

STEP 3 - Replace the sensor with a pre-calibrated sensor and reinstall the sensor end cap. Ensure proper electrical connection between the sensor and the transmitter has been made (the fault indicator will disappear).

STEP 4 - Take the transmitter out of inhibit mode by momentarily placing the magnet over the Z/ESC key. Observe the LCD turns off the INHIBIT indicator. The transmitter is now active.

Storing Sensors

Proper storage of the pre-calibrated sensor is critical to ensure long term functionality of the (spare) sensor. It is important to remember that upon disconnection of the sensor from the transmitter assembly, the bias potential (required by electrochemical sensors) across the sensor's electrodes will be maintained via the integral battery. The battery is capable of providing up to a total of 9 months of "off-line" power (because the battery is not rechargeable, "off-line" time is cumulative), providing proper storage procedures are followed.

When storing the sensor "off-line", block the sensor gas hole by placing a small piece of electrical tape over the front of the sensor (**do not touch the membrane** as this will cause damage to the sensor) and store the sensor in a cool dry place (a refrigerator for example).

Should the sensor be kept off-line for a cumulative period of time exceeding 9 months, the sensor will continue to operate! Battery failure of the sensor does not mean the overall sensor has failed and will not operate, only that it will require a 4-8 hour warm-up time upon installation. Once the sensor has "warmed-up" and has become stable, calibration may occur as normal. An AC-powered sensor keeper (P/N 096-2197) is available for extending the battery life of up to 10 sensors.

Zero Calibration

The transmitter's zero function sets the loop output to 4 mA while the sensor is exposed to air which is free of the gas being detected (and any interferant gases which may be present).

Zero Calibration Using Ambient Air

Ambient air may only be used for the zeroing process if it is certain to be free of both the target gas and any possible interferant; **otherwise, a source zero grade air should be used (except when zeroing an Oxygen transmitter, which uses Nitrogen for this procedure).**

Zero Calibration Procedure

To zero the 4600 GasPlus(MB), proceed as follows:

STEP 1 - Inhibit alarms and the 4-20 mA output by momentarily placing the magnet over the Z/ESC key. Observe the LCD indicates INHIBIT.

STEP 2 - If using a zero air or nitrogen cylinder, attach the calibration adaptor or flow cell to the transmitter. Make all appropriate tubing connections per manufacturer recommendations. Turn on the air flow at a rate of 500 cc/min and let circulate over the sensor for 5 minutes.

! IMPORTANT !

If using the transmitter with an Scott Health & Safety Hydrogen Sulfide Scrubber (P/N 096-2141), the scrubber **MUST** be in place prior to calibration !

STEP 3 - Zero the transmitter by using the magnet and placing it over the over the Z/ESC key on the transmitter body for approximately 5 seconds. Remove the magnet. The display will read "SEt" then "0.0" (the display will vary with range 0, 0.0, or 0.00).

STEP 4 - If spanning the instrument, proceed to "Span Calibration-STEP 2" or take the transmitter out of inhibit mode by momentarily placing the magnet over the Z/ESC key. Observe that the INHIBIT indicator is not visible on the LCD. (The transmitter will automatically deactivate inhibit mode after 9 minutes.)

Span Calibration

When span calibrating the transmitter, the concentration of gas to be used should be at least 50% (BUT NOT IN EXCESS OF 90%) of the transmitter's range. In addition, *if the calibration gas is not in an air balance (nitrogen for example), do not allow the gas to flow across the sensor for more than 5 minutes.* This will deplete oxygen to the sensor and may cause erroneous readings and slow recovery to normal operation (most sensors require a minimum of 5% oxygen for proper operation).

Special Span Calibration Requirements

Hydrides Calibration: Hydride sensors (**AsH₃/Arsine, PH₃/Phosphine, B₂H₆/Diborane, SiH₄/Silane, GeH₄/Germane**) exhibit a significant transient response to changes of oxygen concentration. This response will not effect the sensor's usefulness when operating in normal atmospheric breathing air. However, when calibrating a hydride sensor, hydride gases bottled in backgrounds other than 20.9% oxygen **should not be used**, as the sensor will see a change in oxygen background. For this reason, permeation tube devices are recommended with normal air as a diluent.

Ammonia (NH₃) Note: It is acceptable to use ammonia sensors in reduced oxygen environments (down to 2%) providing that the sensor is stored within the environment for 24 hours prior to calibration in the same environment.

Span Calibration Procedure

To span the 4600 GasPlus(MB) transmitter proceed as follows:

- STEP 1** - Inhibit alarms and the 4-20 mA output by momentarily placing the magnet over the Z/ESC key. Observe the LCD indicates INHIBIT.
- STEP 2** - If using the hydrogen sulfide scrubber (part# 096-2141), ensure that it is in place.
- STEP 3** - Verify that the span gas being used has not exceeded its expiration date. Expired or improperly stored calibration gases can cause inaccurate calibration. A gas concentration of 50 to 90% of full scale is recommended. However, a minimum concentration of 15% of full scale is required.
- STEP 4** - Assemble the specific calibration kit to be used (i.e., permeation tube device, bottled gas, gas generator, etc.) and make the appropriate connections to the transmitter's calibration adaptor. Attach the calibration adaptor to the transmitter's sensor assembly.
- STEP 5** - Initiate gas flow and allow the span gas to flow for approximately 5 minutes at a rate of 500 cc/min. *NOTE: When calibrating outdoors on a windy day, it will be necessary to temporarily cover the holes around the circumference of the rain shield. Otherwise, rapid air flow caused by wind will dilute the gas standard as it enters the sensor area. The holes need not be tightly sealed.* The transmitter should begin to respond to the calibration gas immediately. The indicated gas concentration should slowly level off to a value (usually close to that of the span gas concentration) and remain stable.

! TUBING ALERT !

Ensure the proper tubing is used when performing span calibration. Teflon® tubing should be used when calibrating with chlorine, chlorine dioxide, acid gases, or ammonia.

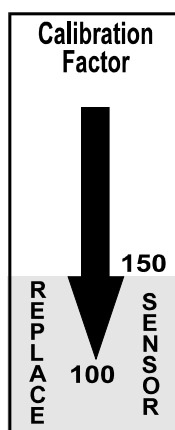

STEP 6 - Once the displayed concentration has stabilized, hold the magnet over the S/ENT key until "SPAN" appears in the display (approximately 5 seconds), then remove the magnet. The gas concentration will then reappear in the display and begin to blink, indicating that it may be adjusted. Place the magnet over the Up arrow (or Down arrow) key to increment (or decrement) the value until it matches the known gas concentration flowing to the sensor. Once the concentration has been adjusted, touch the magnet to the S/ENT key to accept the value, or Z/ESC to abort the calibration without saving any changes. Immediately upon touching the magnet to the S/ENT key:

NOTE! Use only dedicated stainless steel regulators for chlorine gas, as prior use of H₂S can contaminate the regulator and reduce the concentration of Cl₂ as much as 50%

The display shows:	Comments:
WAIT	Compute the calibration factor and update the non-volatile memories.
SET	Memory update was successful.
100-1550	Calibration Factor
RUN	Return to normal display.

The calibration factor has a direct relationship to the output of the sensor. **Sensors having a calibration factor of 150 or less are approaching the end of their useful life and should be replaced soon.**

STEP 7 - Once the displayed concentration has returned to 0, take the transmitter out of inhibit mode by momentarily applying the magnet to the Z/ESC key. Observe that the INHIBIT indicator is no longer visible. (NOTE: The transmitter will automatically return to run mode about 9 minutes after the last adjustment). After calibration is complete, disconnect the calibration system. The unit should now be operating properly and displaying the current gas concentration.

Using A Permeation Tube Device

When using a permeation tube device during a calibration session, it is recommended that constant flow of zero air be established for at least 10 minutes before being hooked up to the calibration adaptor on the sensor. This ensures that any analyte gas which may have been present from a previous span calibration is flushed from the tubing and adaptor.

Optional Sensor Functional Test

Transmitters are designed to operate in many different environments. In some extreme conditions, the sensor may become unresponsive to the target gas due to continuous or excessive exposure to dust or dirt on the membrane, or very high/low humidity conditions.

To ensure a unit continues to function, a sensor test should be considered. Functional tests can be conducted by exposing the sensor to the target gas. Follow all necessary safety precautions while conducting this test. The frequency and necessity of this check is dependent upon the specific characteristics of the site in which the sensor is located and should be determined by the user.

Important Notes on Calibration of Sensors

Calibration of 0-1000 PPM Methyl Iodide Sensor (CH₃I)

Please note that as of March 30, 1999 Scott Health & Safety has released a new high range CH₃I sensor. There is an important calibration method that **MUST** be adhered to when calibrating this sensor. Upon multiple exposures to high concentrations of gas (>500 PPM) it begins to show increased sensitivity for a duration of approximately 5 days. In other words, it provides a higher output when exposed to the same concentration of gas. The increased sensitivity varies from sensor to sensor, but is typically on the order of 30%. After 5 days, the sensor once again shows the same sensitivity as that seen prior to the high gas exposure. This increased sensitivity does not occur for exposure concentrations less than or equal to 200 PPM. Therefore 3 recommendations are being made:

1. The 0-1000 PPM range sensor should not be calibrated any more frequently than once per week.
2. The sensor should be calibrated with actual methyl iodide with a concentration of less than 500 PPM.
3. If the sensor is exposed to a high concentration of gas it should be allowed a recovery period of 7 days before recalibration. Alternatively, it is suggested that a spare GasPlus sensor be kept to swap out any sensor exposed to concentrations greater than 500 PPM. This will allow the "exposed" sensor time to recover.

Keep in mind that exposure concentrations greater than 500 PPM methyl iodide will be unusual. Even if the sensor were to be exposed to a high concentration, the only side effect is increased sensitivity for 3-5 days. If another gas leak occurs, then the sensor will simply overrespond to the gas leak, which is safe-sided.

If you have any questions, please feel free to contact your local Regional Sales Manager or your inside sales support contact at Scott Health & Safety.

New Mandatory Calibration Method of HF Sensors

When spanning HF sensors, using a surrogate gas such as HCl and Cl₂ might be preferred by the operator. When doing this, keep in mind **that the cross-calibration factor used to adjust the span is an estimate based on the average response of several sensors.**

The cross-calibration factor recommended when using HCl (an acidic gas) to span Rock Span HF sensors is approximately 1.3 ppm HF/ppm HCl. Thus, if 5 ppm HCl is used to span a 10 ppm HF sensor, the span should be set to 6.5 ppm HF. For conventional (non-Rock Solid) HF sensors the cross-calibration factor is 1:1.

Cl₂ (an oxidizing gas) may be used to span an HF sensor, **but it is recommended to "bump" test it by exposing the sensors briefly to vinegar vapors to be sure its ability to respond to the acidic HF gas has not been exhausted.** The calibration factor for Cl₂ is about 2.3 ppm HF/ppm Cl₂ for Rock Solid sensors. Thus, when 2 ppm Cl₂ is used to span an HF sensor, the reading should be adjusted to 4.6 ppm HF. For conventional (non-Rock Solid) HF sensors the value is 2.5:1. Therefore 2 ppm Cl₂ applied to a conventional HF sensor should be spanned to 5 ppm.

I. Using a gas generator:

- STEP 1** - Attach the delivery tube from the generator to a calibration adapter. Use the delivery tube supplied by the manufacturer or a length of Teflon[®] or Tygon-clad Teflon[®]. Do not apply to sensor at this time.
- STEP 2** - Start the generator, being sure the flow rate is set to 0.5 lpm and the gas concentration is set to the desired value.
- STEP 3** - Allow the gas to flow through the delivery tube and calibration adapter to let them equilibrate with the gas before connecting to the sensor. Depending on the local environment, this may take 5 to 15 minutes or longer.
- STEP 4** - While waiting, check the sensor zero reading and zero it if necessary.
- STEP 5** - After sufficient time has passed for the gas delivery tube and calibration adapter to equilibrate with the gas flowing through them, attach the calibration adapter to the 4600 sensor end-cap (remove the rain shield first, if there is one).
- STEP 6** - After five minutes, adjust the span to agree with the concentration of gas coming after the generator.
- STEP 7** - Remove the calibration adapter, and re-install the rain shield if necessary.

Note - Some generators¹ don't have air pumps with enough power to overcome the pressure drop of the porous diffuser plug in the calibration adapter. In this case the diffuser must be removed prior to starting the process:

- STEP 1** - With pliers or a 9/16" wrench, remove the barbed hose fitting from the calibration adapter.
- STEP 2** - Through the hole, push out the diffuser with a screwdriver or a pencil. Put the plug in a pocket or other safe place.
- STEP 3** - Replace the hose fitting and tighten.
- STEP 4** - When the calibration process is finished, put the diffuser plug back into its hole and press it until its face is flush with calibration adapter's face.

II. Using calibration gas cylinders

- STEP 1** - Attach a regulator capable of delivering 0.5 lpm gas to the cylinder.
- STEP 2** - Connect the regulator output to a calibration adapter using a length of Teflon[®] tubing or Tygon-clad Teflon[®]. Do not apply to the sensor at this time.
- STEP 3** - Be sure the porous diffuser plug is in place in its hole in the calibration adapter.
- STEP 4** - Allow the gas to flow through the delivery tube and calibration adapter to let them equilibrate with the gas before connecting to the sensor. Depending on the local environment, this may take 5 to 15 minutes or longer.
- STEP 5** - While waiting, check the sensor zero reading and zero it if necessary.

¹ACD's (Advanced Calibration Designs) model 300 and EC Cal Cal-2000 do not have this problem. You may suspect your generator is one that has a weak pump if the sensor's response is "zero" or much lower than anticipated.

STEP 6 - After the delivery tube and adapter have equilibrated with the gas, attach the adapter to the 4600 sensor end-cap (remove the rain shield first, if there is one.)

STEP 7 - Continue the gas flow and after five minutes, adjust the span to agree with cylinder label value.

STEP 8 - Shut off the gas, remove the calibration adapter from the end-cap, and reinstall the rain shield if there is one.

Note - Sometimes regulators require time to adjust after changing from one gas type to another. For example, a regulator that has been on an H₂S cylinder will have absorbed H₂S, especially when it is brass. The sulfided interior will destroy gasses such as Cl₂ until enough time and gas have passed to "clean out" the regulator. In extreme cases, it will probably be better to use a new regulator and then reserve it exclusively for use with the particular gas (i.e. chlorine).

Weekly Operational Response Checks

A sensor response test should be performed weekly to ensure the transmitter continues to respond to the target gas. It is recommended to briefly expose the transmitter to a dose of the calibration gas used to span the instrument. A 5 to 10 second gas stream directed at the base of the sensor should suffice in producing a response from the transmitter.

If response is slow (typical response time will be within 5 seconds), check the tip of the sensor for either dirt buildup or condensation on the membrane. Both can cause slower than normal operation. If an excessive dirt buildup is present, the sensor is generally not repairable. If there is excessive moisture present, the sensor may be removed to a dry area and permitted to dry.

Under such conditions, the cause of the excessive moisture should be determined and prevented (condensing humidity, hose-downs, etc.)

Refer to the appendix for alternative methods of generating operational check gases.

Adjusting the Loop Output Parameters

Adjusting the 4-20 mA Output (COMM Menu - MA.04 and MA.20)

Once the transmitter is installed and wired to the current loop, the 4-20 mA levels may be adjusted through the user interface to overcome line or receiver resistance problems. In addition, the current loop may be forced to a level between 1.00 and 20.0 mA for purposes of testing alarms back at the receiver. In order to perform this adjustment, you must be able to monitor the current loop at the receiving device.

- 1. This adjustment requires the loop current to be monitored at the receiving device. Refer to the electrical connections drawings in the installation section of this manual.**
- 2. To prevent false alarms at the receiver, set the receiver channel to alarm inhibit prior to making these adjustments.**

To adjust the 4 and 20 mA output from RUN mode:

STEP 1 - Touch the magnet to the Up arrow key and observe "USER" in the display.



STEP 2 - Touch the magnet to the Up arrow key until "COMM" appears in the display.

STEP 3 - Touch the magnet to the S/ENT key and observe "MA.04" in the display.

STEP 4 - Touch the magnet to the S/ENT key and observe the DAC value (in hexadecimal) corresponding to an output current of 4.00 mA.

NOTE: Since the current loop has already been calibrated at the factory, this value will be different than the default value. Hold the magnet on the Up arrow key to increase the current loop output (or the Down arrow key to decrease) until the receiver indicates exactly 4.00 mA. Touch the magnet to the S/ENT key and observe "SET" on the display. When finished, or if no changes are required, touch the magnet to the Z/ESC key to return to the "MA.04" display.

STEP 5 - Touch the magnet to the Up arrow key and observe the display changes to "MA.20".

STEP 6 - Touch the magnet to the S/ENT key and observe the DAC value (in hexadecimal) corresponding to an output current of 20.0 mA. Hold the magnet over either the Up or Down arrow keys until the receiver indicates it is receiving exactly 20.0 mA., then touch the magnet to the S/ENT key and observe "SET" on the display. When finished, or if no changes are required, touch the magnet to the Z/ESC key 3 times to return to RUN mode.

Setting Loop Fault and Inhibit Levels (COMM Menu - MA.F and MA.I)

To indicate abnormal conditions, the transmitter may be programmed to output a current loop level corresponding to either a fault or inhibit state. The "MA.F" and "MA.I" parameters, found in the COMM menu, determine the actual milliampere values which are output during fault and inhibit conditions, respectively.

Testing the 4-20 mA Output (COMM Menu - MA.t)

The MA.t parameter is used to drive loop current to simulated alarm conditions to test a receiver device. Any value between 1.00 and 20.0 mA can be programmed into the transmitter. The "test" output will automatically shut off when exiting the menu. If no keys are pressed the unit will return to run mode in two minutes.

Optional Alarm Relays

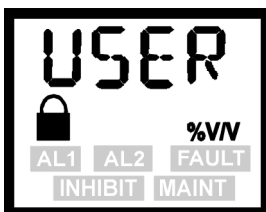

The transmitter has 3 optional alarm relays: 2 concentration alarms and 1 fault alarm. Active alarms are displayed on the LCD. **The appearance of these alarm indicators does not imply that the associated relay is also active, since the relays are inactive during inhibit.** When the INHIBIT indicator is visible, alarm and fault conditions may be indicated, but their associated relays are held in their normal states (note: fail safe relays will be held energized during inhibit).

Alarms are inhibited automatically at power on (for 30 seconds), and by

touching the Z/ESC key briefly with the magnet. When the Z/ESC is used, alarms are inhibited for 9 minutes. The period may be reprogrammed by changing the value of the **AL.IP** parameter in the USER menu.

Changing Alarm Set-Up Parameters

Using the magnet, access the USER menu and select the desired alarm parameter. Use the Up or Down arrow keys to increment or decrement the value, then touch the magnet to the S/ENT key to store the reading (observe "SET" on the display) or the Z/ESC key to abort. Use the Z/ESC key to return to the RUN mode.

Set Points and Reset Points

The transmitter has two concentration alarms that may be programmed as either a rising or falling alarm.

Rising Alarm: Set point is at or above reset point.

The alarm activates when the gas concentration rises to the set point value.

The alarm deactivates when the gas concentration falls to the reset point value.

Falling Alarm: Set point is below reset point.

The alarm activates when the gas concentration falls to the set point value.

The alarm deactivates when the gas concentration rises to the reset point value.

Set and Reset Delays

A set delay prevents an alarm from activating until the alarm condition has been above the setpoint for a certain amount of time. A reset delay prevents a non-latching alarm from deactivating until the alarm condition has been below the reset point for a certain amount of time.

Reset delays are often used to control ventilation fans (i.e., the fans are kept on past the danger point to ensure that the hazardous condition is absent throughout the area and not just around the transmitter). Set delays are sometimes used to avoid "nuisance trips". ***The use of lengthy set delays is strongly discouraged.***

Latching / Non-Latching and Non-Fail-safe / Fail-safe Operation

The relays can be used in latching and non-latching modes, and can be fail-safe or non-fail-safe. In fail-safe operation, relays are normally energized and de-energized upon alarm activation (in non-fail-safe operation the relays are normally de-energized). In latching mode, alarm indicators must be manually reset by touching any key with the magnet. ***Note that alarm indicators and relays can only be reset if the measured concentration is at or below the reset point (or above the reset point if programmed as a falling alarm).***

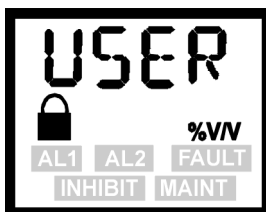

Relay NO/NC Status

The relay's NO or NC configuration *IS SPECIFIED WHEN ORDERING THE TRANSMITTER.*

Position describes the relay's state when it is inactivated. Normally open (NO) relays represent a break in the circuit; the circuit is completed when the relay is activated. In contrast, with a normally closed (NC) relay the circuit is broken when the relay is activated. Note that a relay's position (open or closed) is independent of its activation mechanism (energized or de-energized).

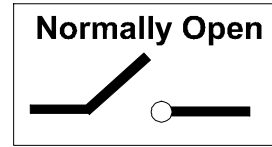
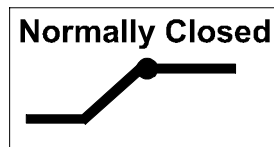

IMPORTANT



Alarm **Concentration** relays assume a non-fail-safe operation and the **Fault** relay assumes fail-safe operation. **Changing these modes will reverse the normally open/normally closed status.**

Damping Time Constant

The SR.dC parameter sets the time constant of the digital lag filter which the software uses to smooth variations of the input signal. The parameter value specifies the number of seconds required to reach 63% of its final value. Multiplying the SR.dC value to 3 (3 time constants) will result in the number of seconds required to reach 95% of final value.

Transmitter Security

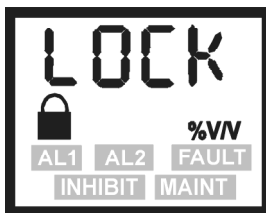

Transmitter password protection is accessed through the **LOCK Menu**. The 4600 Gas Plus(MB) transmitter employs password protection as means of prohibiting unauthorized access to calibrations and critical parameter settings. When the lock is enabled (lock icon appears on display), parameters may be viewed but not changed until the lock is disabled (no icon visible). The lock is toggled on and off by simply entering the password at the LK.ON parameter (default 000). This 3-digit password may be changed via the LK.PW field. Once unlocked, the transmitter may be programmed to re-lock itself automatically after a specified period.



toggling Parameter Security On/Off (LK.ON)

To toggle the state of the lock, scroll to the LK.ON parameter in the LOCK Menu and touch the magnet to the S/ENT key. Observe the display changes to 000. Hold the magnet on the Up arrow key until the display changes to the stored password (000 by default) and touch the S/ENT key. Observe the display shows "SET" momentarily, and the lock icon appears (if enabling security) or disappears (if disabling security). If the wrong password is entered, "ERR" will appear on the display.

Changing the Password (LK.PW)

The password is located in the LOCK menu as the LK.PW parameter. When the system is unlocked (no icon visible), the password may be viewed and changed just like any other parameter. However, when the system is locked the password is displayed as 000. Attempting to enter a new password will result in a display of "ERR" instead of "SET".

Auto-Lock Timer (LK.tM)

As an option, parameter security is automatically re-enabled (after being toggled off) by specifying a nonzero value in the LK.tM parameter. The value appearing in the LK.tM parameter is the number of minutes (1 to 90) which the transmitter remains unlocked before automatically re-locking itself (the feature is disabled when LK.tM=0). The time-out period begins at the moment the transmitter is unlocked and will re-lock only after the period has expired and the mode has returned to RUN mode (the transmitter will not self lock during parameter editing). Note that the instrument always returns to RUN mode if no keys have been activated for 2 minutes. Additionally, if the transmitter experiences a hardware reset (i.e., power cycle) with a nonzero value programmed in the LK.tM parameter, it will immediately enable the security.

Instrument Parameter Change Example

The example below will permit you to practice using the interface while actually setting the alarm 1 parameters.

1. With the instrument in RUN mode, place the magnet on the Up arrow key and observe "USER" in the display. This is the user menu selection. Remove the magnet before the next selection scrolls into the display. If another selection does scroll in, repeat touching the Up arrow key until "USER" is finally displayed.
2. Place the magnet on the S/ENT key and observe "A1.SP" on the display. This is the alarm 1 set point selection. Remove the magnet.
3. Place the magnet on the S/ENT key again and observe "25.00" (this may be different if already reprogrammed from the factory value). Remove the magnet.
4. Hold the magnet over the Down arrow key to decrement the value, or the Up arrow key to increment the value as desired. When the desired value is displayed, remove the magnet.
5. To save the new value, place the magnet over the S/ENT key and observe "SEt" in the display. The new value is saved in user parameter memory and the user parameter checksums are updated. If a parameter memory error is detected while saving the new value, "ERR" will be displayed (and the appropriate fault code will be displayed upon returning to RUN mode). Place the magnet over the Z/ESC key to return to the "A1.SP" selection.
6. To abort changes to the old value, place the magnet over the Z/ESC key and observe the display returns to the "A1.SP" selection.
7. Place the magnet momentarily over the Up arrow key and observe the display changes to "A1.RP". This is the alarm 1 reset point. Place the magnet over the S/ENT key to display the reset point value. Use the magnet over the Up and Down arrow keys to change to the desired value. Place the magnet over the S/ENT key to save the new value and observe "SEt" in the display. If the value cannot be saved in memory, "ERR" will be displayed. Place the magnet over the Z/ESC key to return to "A1.RP" selection.
8. Momentarily touch the Up arrow key and observe "A1.Sd". This is the alarm 1 set delay value in seconds. Use the same procedure detailed in steps 3-7 to set the desired value, and select and set the remaining alarm parameters: "A1.Rd" and "A1.OP" (reset delay).

Sensor Self Test Option

SST Operation

The Sensor Self Test (SST) option provides a means for automatically testing the electrochemical gas sensor. This is equivalent to the traditional bump testing of a sensor. Although not a calibration test, it does automatically indicate when the sensor is no longer able to respond to a gas leak. This powerful feature provides additional confidence in your gas detection system. Contact your local SCOTT/ Instruments representative to ascertain which sensors can be fitted with this option. The controls for starting and stopping the Self Test function are found in the User Menu.

When the St.ON control is set to OFF, the sensor self test is immediately stopped and future tests are disabled until the control is set to ON or NOW. This also clears the self test fault.

When the St.ON control is set to ON, the sensor self test may occur twice daily at the times specified by St.t1 and St.t2. The test will then be repeated at intervals from every 1 to 60 days (St.dt).

When the St.ON control is set to NOW, the sensor self-test will occur immediately and the control will return to its previous state – OFF or ON.

During Sensor Self Test:

1. Before turning on the gas generator, the instrument verifies that there are no existing sensor faults and the existing gas concentration reading is below 5%FS. If the concentration is at or above 5%FS, the instrument waits up to 1 hour for the concentration to subside. If gas is still present after 1 hour, the self test is aborted and the MAINT indicator is displayed. The F.MNt parameter in the factory menu will be appended with an appropriate maintenance code and will need to be set to 0 in order to eliminate the MAINT indicator. Toggling power on and off to the instrument will also clear the maintenance code (S5 on the CPU board). The word "SELFTEST" scrolls in the display and the St.ON bit in the Modbus® STS status register is set to 1 throughout the test.
2. Once the instrument has verified there is no gas present above 5%FS, it turns on the gas generator and waits for the concentration to rise to 10 %FS or more. At this time:
 - a. Alarms are inhibited,
 - b. The current loop output is driven to the inhibit level (MA.I value in the COMM menu),
 - c. The inhibit indicator appears in the display.
3. When the measured concentration reaches 10%FS, the word "PASS" appears in display and the instrument enters a recovery period. If the sensor output fails to rise to 10%FS or more, the FAULT indicator appears. The test is repeated every 10 minutes until successful, or until the St.ON control is set to OFF, or until power is switched off and back to on. If the transmitter is in RUN mode, a fault code scrolls in the display. Touching the magnet to the S/ENT key will cause the SELF-TEST-FAIL message to then scroll in the display. The fault indication is cleared by:

- a. Successful completion of the next self-test (scheduled or manual),
 - b. Changing the St.ON control to OFF,
 - c. Toggling power to the instrument (S5 on the CPU board).
4. After successfully measuring a concentration of 10%FS or more, the instrument turns off the gas generator and enters a recovery period while maintaining the inhibit state. This state is maintained until the measured concentration drops to 5%FS or below, but does not exceed the time specified in seconds by the SR.Rt parameter (self-test recovery time). Upon return to normal operation, alarm and current loop operation return to normal and the St.ON bit in the transmitter status register is cleared. Note that alarms may occur if recovery period expires and the gas concentration has not subsided below the two alarm reset points. If this should occur, increase the recovery time specified by St.Rt.

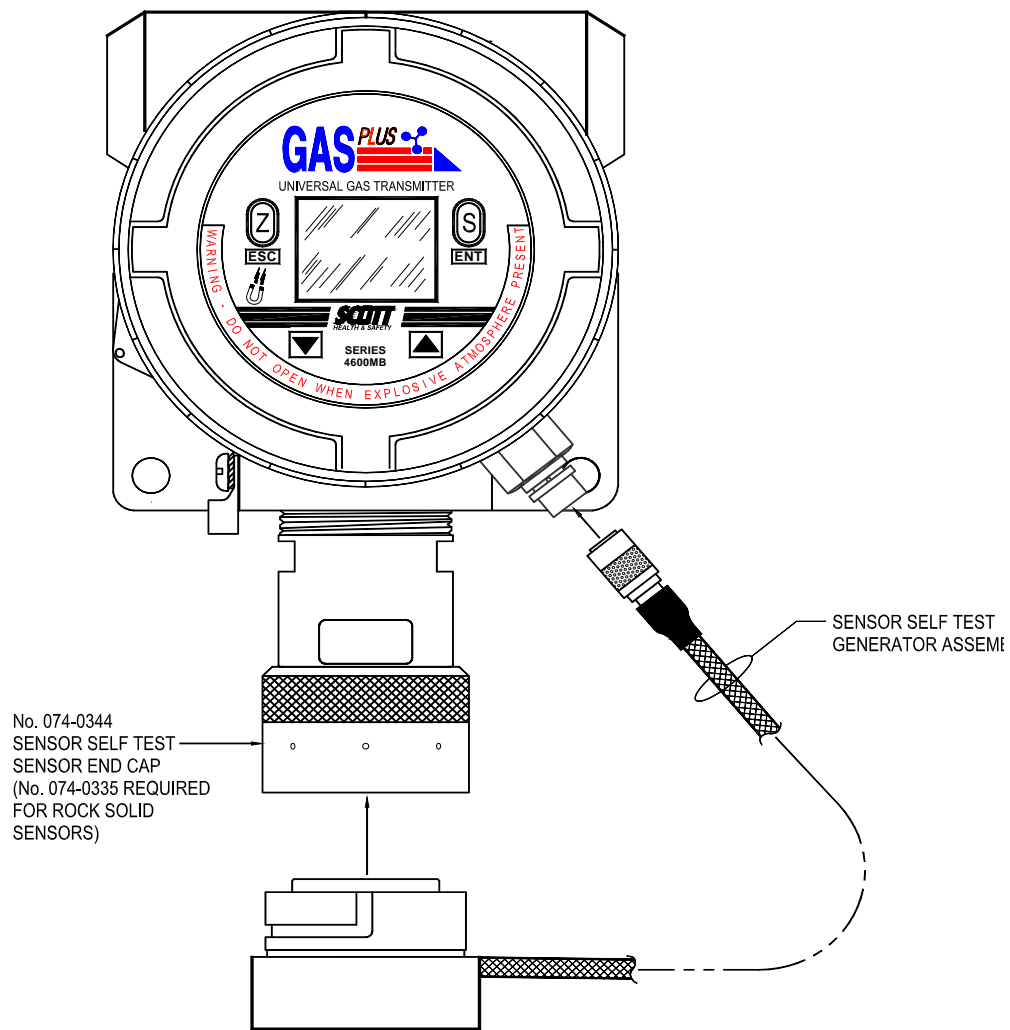

Figure 13 - Sensor Self Test Generator

Serial Communications

Overview

There are 2 serial communication protocols in the 4600 GasPlus(MB) transmitter. The first protocol is an ASCII report line which is transmitted in response to a poll from a master receiver, or may be transmitted automatically at programmed time intervals. The content of the report line is configurable; i.e., each field may specify date, time, temperature, concentration, alarm status, or even specify a blank field for formatting a report for import into a spreadsheet. Aside from parity and framing errors, ASCII protocol does not explicitly provide a means for verifying transmitted message data. The composition of this report is detailed in the Report Generation section later in this manual.

The second protocol is Modbus[®] RTU in which a master device transmits queries to the slave transmitter and reads back response messages. In addition to framing and parity errors, Modbus[®] RTU protocol appends 2 Cyclic Redundancy Check (CRC) bytes on the end of each message. These 2 bytes are generated from the value and order of bits in the message and provide a high degree of data integrity. Note that the transmitter does not support the Modbus[®] ASCII protocol.

Each protocol is capable of using either the RS-232 or RS-485 electrical interface. The RS-232 interface is designed for connecting only 2 devices over relatively short distances (less than 50 feet at 9600 baud). This might be used for transmitting timed ASCII reports to a serial printer or computer with a built-in RS-232 port.

The RS-485 interface is used for connecting a multi-drop network of up to 31 devices using Modbus[®] protocol. Since RS-485 is transmitted differentially (each bit is determined by the differential voltage between 2 wires), transmitters may be located at distances of up to 1500 meters from a master computer or RTU operating at 38.4k baud. Note: All devices must be configured for the same transmission rate (typically 9600).

Setting Up For Serial Communications

Wiring the 4600 transmitter for serial communication is not much different than for analog transmission. However, slight differences exist depending on whether RS-485 and RS-232 data transmission is used.

While RS-232 buses require no termination resistors, multi-drop RS-485 buses must be terminated on both ends by a resistor that matches the characteristic impedance of the transmission line, which is typically between 100 Ω and 120 Ω (the characteristic impedance should be provided in the cable's technical specifications). The transmitter CPU board contains a jumper selectable 120 Ω termination resistor. This resistor is jumpered in or out by installing the appropriate plug on J6 of the CPU board (see Figure 9 on page 18 for specific connection details).

Note that serial communication may be used in conjunction with the 4-20 mA current loop output. If the current loop output is not used, it must be properly terminated inside the transmitter at TBI (see Figure 4 on page 12).

The 4600 GasPlus(MB) will typically use RS-485 with Modbus® protocol, and RS-232 with ASCII protocol.

Once a device is powered and connected to the bus (see Electrical Installation drawings), it needs to be configured for use with the master. All communications parameters are contained within the COMM menu. Note that these settings (except for SC.Ad instrument address parameter) **must be the same for all devices on the network** (including the master).

The table below summarizes the characteristics of each data transmission method.

Comparison of Data Transmission Methods			
	<u>4-20mA</u>	<u>RS-232C</u>	<u>RS-485</u>
Data Format	Analog	Digital	Digital
Transmission type	Current loop	Referred to ground	Differential
Max. transmitting devices	1	1	32*
Max. receiving devices	1	1	32*
Max. line length	n/a	15m	1,000m
Max. transmission rate	n/a	38.4 kB/s	90-500 kB/s

**The number of transmitting and receiving devices on an RS-485 bus can be increased by the use of repeaters.*

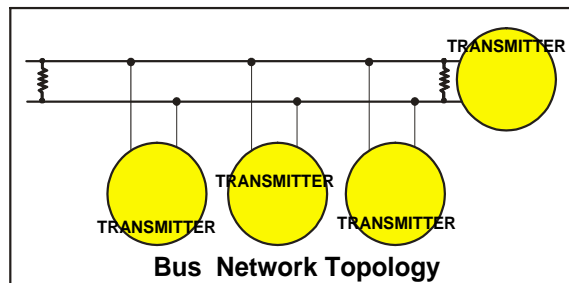

RS-485/232 Topology

Because RS-485 (and RS-232) transmission uses 2 wires for communications, instruments using this method are 4-wire devices (2 wires for power, 2 wires for communications). Note that RS-485 cable, such as Belden 9841 and Manhattan 3993, should be used instead of standard 18AWG instrumentation cable.

RS-485 limits the number of slave devices to 32. This limit is driven by power considerations and can be overcome through the use of repeaters (also called extenders), each of which allows another 32 devices and 1,000m to be added to the bus. Modbus® protocol limits the number of slave devices to 247.

Modbus® RTU Protocol

Modbus® RTU protocol is a binary master/slave protocol that can support the transfer of data between a master and up to 247 slaves. The master initiates every message with a query directed at a particular slave and looks for a response from only that slave. The master can also broadcast a message to all slaves in which case it does not expect any response. The format of the query and the response are very similar and end with 2 CRC bytes. Although the master and slave cannot correct data errors, the CRC bytes provide a high level error detection. The Modbus® protocol also defines appropriate responses when errors are detected.

MODBUS® Communications

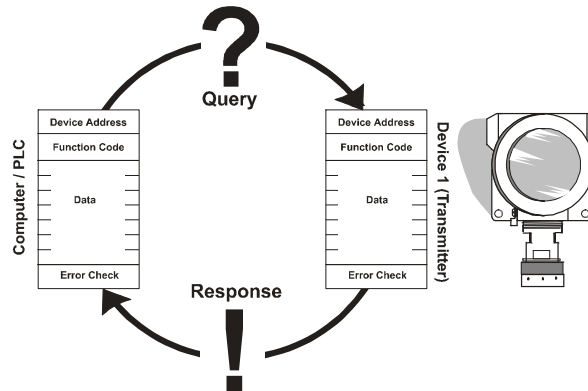

Query and response messages start and end with a silent interval of at least 3.5 character times. The entire message must be transmitted as a continuous byte stream. If a silent interval of more 1.5 characters occurs before completion of the message, the receiving device flushes the incomplete message and waits for the next message. Similarly, if a new message occurs earlier than 3.5 character times following a previous message, the receiving device will consider it a continuation of the previous message and a CRC error will be generated.

The device address field appears in both the query and the response messages. Valid device addresses are limited to the range of 1-247. The function field also appears in both the query and response messages. The function field specifies whether the master is reading or writing data to the slave. The function field also specifies whether the data is addressed as a single register, or a block of registers. The 4600 Gas Plus(MB) transmitter supports Functions 1-8 and 15-19, which is the same as the Modicon 884 controller.

Transmitter data is organized into 16-bit registers, numbered 40001 to 49999, and addressed at the protocol level as 0000 to 9998. Variables and configuration parameters are permanently mapped to these registers and may occupy 1 or more according to their data type. A complete register map follows in Appendix 1 at the rear of this manual. More information on Modbus® protocol may be obtained from Modicon, Inc.

Modbus® Applications

Modbus® application programs (applications) usually run on a DCS (Distributed Control System), PLC (Programmable Logic Controller), or industrial computer. Examples of applications running on industrial computers include Citect®, Wonderware®, and FIX DMAPS. In addition to the register number, an application must have other information about the variables and configuration parameters it needs to access (some applications may require the protocol address, which is derived from the register number by subtracting 40001).

Typically, an application has an interface which builds a tag data base and is referred to as 'tagging'. Each record in the tag data base associates a symbolic name with information about where to find the data (the slave device and register number), the size of the data (how many registers to access), and the range of the data (for run time integrity checking). An example of this is shown below:

- Tag Name** ...symbolic name field used to identify this record
- Slave Identifier** ...name of the slave device (determined by the slave address)
- Register Address** ...address of the first 16 bit register containing the Data
- Data Type** ...INTEGER, LONG, REAL, STRING, etc.
- Data Range** ...minimum and maximum values of the data

In addition to the above, a tag record may also contain fields for proper scaling and formatting of the data.

The table below illustrates a partial tag database used by Citect®.

NAME	TYPE	UNIT	ADDR	RAW_ZERO	RAW_FULL	ENG_ZERO	ENG_FULL	ENG_UNITS	FORMAT
GAS_1	REAL	EIT46MB1	40019	0	100.0	0	100.0	PCT	### EU
TEMP_1	REAL	EIT46MB1	40021	0	100.0	0	100.0	DEG	### EU
GAS_2	REAL	EIT46MB2	40019	0	100.0	0	100.0	PCT	### EU
TEMP_2	REAL	EIT46MB2	40021	0	100.0	0	100.0	DEG	### EU

Since Modbus® registers are defined to be 16 bits wide, LONG and REAL data types require 2 consecutive registers and STRING data types may require 1 register for every 2 characters. In most applications, the master software will read the proper number of registers according to the data type. In addition, the master software should provide a means for byte reversing these types to accommodate 'big endian' and 'little endian' problems.

Modbus® drivers are usually supplied with industrial computer SCADA and MMI programs such as Citect®, Wonderware®, and FIX DMAPS. If you are integrating the 4600 Gas Plus(MB) transmitter with a DCS or PLC system, it may be important to know that the 4600 Gas Plus(MB) transmitter most closely emulates the Modicon 884 PLC in that it supports Modbus® Functions 1-8 and 15-19.

Transmitter Registers

The table below lists the first 26 registers for the 4600 Gas Plus(MB) transmitter. Register numbers 40019 to 40026 contain the most important data that the transmitter produces. By structuring this data into consecutive registers, applications may read the entire register block with 1 transaction. This helps to increase the bandwidth of a network of transmitters by eliminating extra messages if the data were noncontiguous.

Register Number	Register Address	Description	Suggested Tag
40001	0000	Function Select Register	FSR
40002	0001	Parameter Select Register	PSR
40003-40006	0002-0005	Character Data Registers	CDR1 - CDR4
40007-40010	0006-0009	Integer Data Registers	IDR1 - IDR4
40019, 40020	0018, 0019	Gas Concentration, Decimal Point	GAS, GAS_DP
40021, 40022	0020, 0021	Temperature, Decimal Point	TMP, TMP_DP
40023	0022	Transmitter Status	STS
40024	0023	General Fault Status	GFS
40025	0024	Sensor Fault Status	SFS
40026	0025	Transmitter Type (=4600)	TYP

A complete list of parameters can be found in the Parameter Reference section of this manual.

Accessing Transmitter Data

The transmitter stores volatile information, such as computed concentration, temperature, and alarm status in RAM. Configuration parameters, such as alarm set points and current loop settings, are stored in nonvolatile EEPROM. There are no restrictions on reading any transmitter variable or parameter, providing you know the register number and data type. However, this is not the case for configuration parameters. Since the nonvolatile memory is checked before each series of calculations, a special procedure must be used to change configuration parameters.

Important!: Do not write directly to the address of a parameter. Doing so will result in a memory checksum fault.

Changing Configuration Parameters

To change a configuration parameter value you must have 1 more piece of information - the parameter number. Parameter numbers provide an index into an internal parameter table which describe the data type and range to the functions that control the editing of parameters. These are the very same routines that control editing through the display and magnetic keys. The sequence for changing a parameter value is shown below.

1. Write the new value to the appropriate data register; IDR1 for integers or CDR1 for characters.
2. Write the parameter number to the parameter select register, PSR.
3. Write the appropriate function code (command) to the function select register, FSR.
4. Read the STS register to verify the RFF bit is 0 (no errors).

It is permissible to write all 3 registers at the same time; however, your application must ensure that the FSR is not written before the other registers have been set properly. Failure to do so may result with parameters being set to unknown values resulting in a dangerous transmitter configuration (i.e., alarm set points too high). Always verify new parameter values either manually or through the Modbus® interface. Character data must reside in the low byte of the 16 bit register value with the upper byte all zeros. Function codes are listed in Appendix 2.

Example

Read and Change a Parameter Value

Objective: Given a 10.0 PPM Chlorine Sensor:

1. Read the current value of the alarm 2 set point (default value=2.5), and
2. Change the alarm 2 set point value from the current value to 2.0.

How to Read the Current Value of the Alarm 2 Set Point

The alarm 2 set point is read as (2) 16-bit registers at 40283 and 40284. The first register is a signed 16-bit integer representing the numeric digits of the value. The second register is a READ ONLY value representing the number of digits to the right of the decimal point: 0, 1, 2, or 3 (never attempt to change any of the decimal point registers). If we tag (name) the first register as SP1 (40283) and tag the second register as SP1_DP (40284), we can convert the alarm 2 set point to a real value. The following is an example written in BASIC which converts the alarm 2 set point integer value into a single precision value. Note that some SCADA and MMI languages mimic the BASIC programming language. The principal difference is that SCADA/MMI programs maintain a tag database which permit you to reference Modbus® registers using a tag name such as "SP2".

'...BASIC language algorithm to convert SP2 from INTEGER to SINGLE. Two library functions 'are assumed to exist that read and write transmitter registers using Modbus® protocol. 'Their implementation is beyond the scope of this manual.

```
DIM SP2 AS INTEGER
DIM SP2_DP AS INTEGER
DIM SP2_REAL AS SINGLE.
SP2 = MB_Read_Reg (40283)
SP2_DP = MB_Read_Reg (40284)
SELECT CASE SP2_DP
CASE 0
    SP2_REAL=SP2
CASE 1
    SP2_REAL=SP2*0.1
CASE 2
    SP2_REAL=SP2*0.01
CASE 3
    SP2_REAL=SP2*0.001
CASE ELSE
    PRINT " * * * SP2 Decimal Point Error
END SELECT
```

How to Change the Alarm 2 Set Point

Since parameter memory is continuously tested for integrity, parameter values may NOT be written directly to parameter read addresses. Doing so will cause a checksum fault on the very next scan. In addition, writing a parameter value directly into memory provides no range of error checking as provided when using the display and switches at the operator interface. This level of integrity checking requires the parameter access registers. On the 4600 GasPlus(MB), these registers are 40001 through 40010:

Register Address	Description	Input Range
40001	Function Select Register (FSR)	See Appendix 2
40002	Parameter Select Register (PSR)	0-100 (see Parameter Reference Guide)
40003-40006	Character Data Registers (CRD1-CRD4)	- 128 to 127
40007-40010	Integer Data Registers (IDR1-IDR4)	-32768 to 32767

In our example, you will only need to change the numeric value contained in Register 40283. This is accomplished in 3 steps that appear in the following sequence:

- STEP 1 - Since the data we are attempting to update is an integer, we start by writing the new alarm value into IDR1 (40007). However, you must always take care to compensate the new value for the decimal point. In our example, the 10 PPM chlorine sensor forces the alarm set/reset decimal points to 1 (1 decimal digit). Therefore, the value written to IDR1 must be 20 to represent 2.0.
- STEP 2 - The next step is to write the parameter number into the PSR Register. The alarm 2 set point (A2.SP) parameter number is 9 as listed in the Parameter Reference Guide.
- STEP 3 - The last step is to write an appropriate command function value to the FSR Register. Since the parameter data type we are attempting to write is a 16-bit integer, the FSR value required is 2 (see "Write 16-Bit Integer Parameter").

The following example illustrates how this might appear in a BASIC language program:

```

MB_Write_Reg (40007,20) ' comment: IDR1=20, since SP2_DP=1 this is 2.0
MB_Write_Reg (40002,9) ' comment: PSR=9, A2.SP is parameter #2
MB_Write_Reg (40001,2) ' comment: FSR=2, command to write 16-bit integer in IDR1
    
```

The decimal point register (40284) should never be written to, as it is read-only.

CAUTION! Do use the Modbus® Interface to change any of the alarm set/reset decimal point registers. This information is critical to the operation of the instrument.

Modbus® is a registered trademark of Modicon,Inc.

Report Generation

This Report function would typically be accessed in the field through the RS-232 connection with the output going to a portable printer, datalogger, or PC.

Report generation is accomplished through the **COMM Menu**. Through the user interface, you may program the 4600 GasPlus(MB) to generate one-line reports at intervals ranging from once every second to once every 2 hours (7200 seconds). Alternatively, you may set the instrument to transmit a report in response to a poll. The format of this poll is: #nnn(CR), where # is the ASCII (35 decimal) and nnn is the instrument address in ASCII decimal, and (CR) is ASCII 13 decimal (carriage return).

Examples:

Poll instrument 2: #002(CR)

Poll instrument 100: #100(CR)

These reports contain the instrument ID (001-247) and up to 8 fields for data such as date, time, temperature, gas concentration, and alarm status. Additionally, the format of the 1 line report may be controlled for easy import into word processing or spreadsheet programs such as Microsoft Word® and Microsoft Excel®.

The data that is printed in each of the 8 fields is specified by selecting the appropriate field label in the RP.F1 through RP.F8 parameters. RP parameters are found in the COMM menu.

In addition to controlling the fields, you also have control over the delimiters appearing between the fields and the termination characters appearing at the end of the line. For these strings, you may specify up to 5 ASCII characters (including spaces, commas, tabs, quotes, etc.). All you need to know are the hexadecimal ASCII codes for each character in the string. If the delimiter or termination string is less than 5 characters, you must enter 0 after the last character. Characters appearing after the 0 will be ignored.

An example of the default report format is shown.

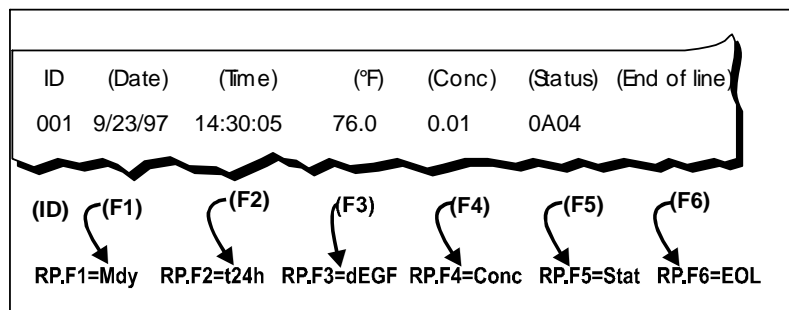

The report consists of the ID, date, time, temperature in Fahrenheit, gas concentration, and the alarm/relay status. The delimiter string is a single space which is defined as hexadecimal 20 (decimal 32), and the termination string is the carriage return and line feed characters represented as hexadecimal 0d (decimal 13), and hexadecimal 0A (decimal 10), respectively.

Parameter Reference

Menus

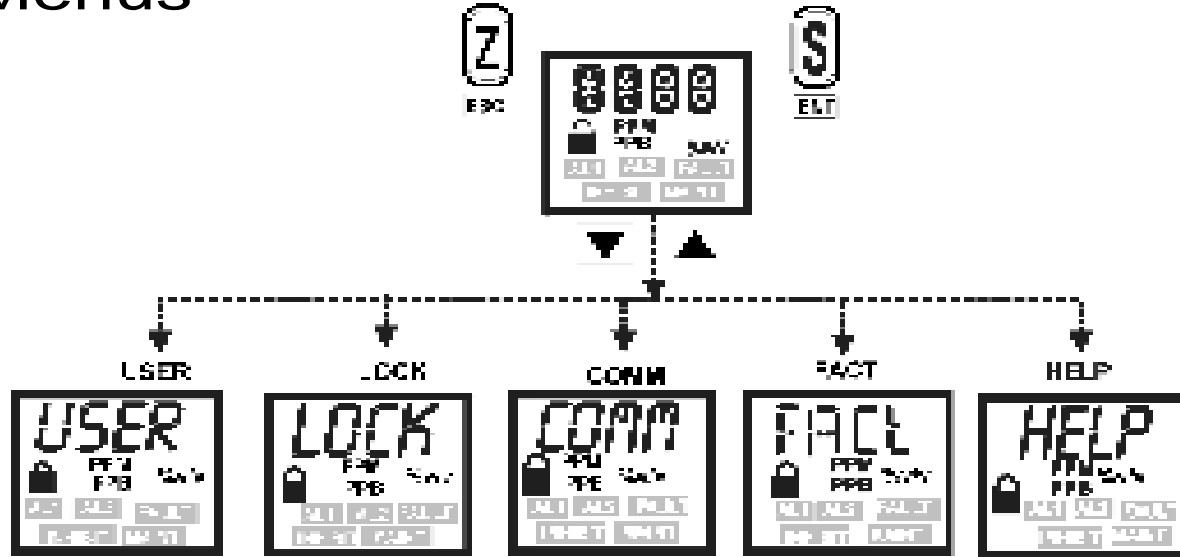

<p>Alarm and Sensor Parameters Adjusts alarm setpoints, relay operation, and various sensor parameters such as gas type and display engineering units.</p> <p>Alarm Parameters:</p> <table border="0"> <tr><td>A1.SP</td><td>A2.Sd</td></tr> <tr><td>A1.RP</td><td>A2.Rd</td></tr> <tr><td>A1.Sd</td><td>A2.OP</td></tr> <tr><td>A1.Rd</td><td>AF.NL</td></tr> <tr><td>A1.OP</td><td>AF.OP</td></tr> <tr><td>A2.SP</td><td>AL.IP</td></tr> <tr><td>A2.RP</td><td>AL.tO</td></tr> </table> <p>Sensor Parameters:</p> <table border="0"> <tr><td>SR.dC</td><td>St.t1</td></tr> <tr><td>SR.tC</td><td>St.t2</td></tr> <tr><td>SR.tF</td><td>St.Gt</td></tr> <tr><td>St.ON</td><td>St.Rt</td></tr> <tr><td>St.dt</td><td></td></tr> </table>	A1.SP	A2.Sd	A1.RP	A2.Rd	A1.Sd	A2.OP	A1.Rd	AF.NL	A1.OP	AF.OP	A2.SP	AL.IP	A2.RP	AL.tO	SR.dC	St.t1	SR.tC	St.t2	SR.tF	St.Gt	St.ON	St.Rt	St.dt		<p>Lock Functions Used to secure system parameters from tampering.</p> <p>LK.ON LK.PW LK.tM</p>	<p>Communications Functions Adjusts transmitter 4-20 mA out, serial communications, and report generator parameters.</p> <p>Current Loop</p> <p>MA.04 MA.20 MA.SF MA.F MA.I MA.t</p> <p>Report Generator</p> <p>RP.ON RP.Pd RP.d1 thru RP.d5 RP.E1 thru RP.E5 RP.F1 thru RP.F8</p> <p>Real Time Clock</p> <p>Rt.dt Rt.YR Rt.tM</p> <p>Serial Comm</p> <table border="0"> <tr><td>SC.Ad</td><td>SC.Md</td></tr> <tr><td>SC.bd</td><td>SC.OP</td></tr> <tr><td>SC.dL</td><td>SC.P</td></tr> <tr><td>SC.Id</td><td>SC.RS</td></tr> </table>	SC.Ad	SC.Md	SC.bd	SC.OP	SC.dL	SC.P	SC.Id	SC.RS	<p>Factory Functions Used by factory for diagnostics and adjustments.</p> <p>F.PWd F.tMR F.CAL F.HtC F.RES F.MNt F.ZMV F.SCF F.SMV F.tCF F.LSd F.LSt F.SGC F.StC F.tYP F.RNG F.dPG F.GCU F.SP1</p> <p>F.SP2 F.MFG F.SSN F.096 F.CS1 F.CS2 F.CS3 F.LbF F.LCd SW.1d</p>	<p>Help Functions A scrolling help message appears for each parameter in all menus.</p>
A1.SP	A2.Sd																																			
A1.RP	A2.Rd																																			
A1.Sd	A2.OP																																			
A1.Rd	AF.NL																																			
A1.OP	AF.OP																																			
A2.SP	AL.IP																																			
A2.RP	AL.tO																																			
SR.dC	St.t1																																			
SR.tC	St.t2																																			
SR.tF	St.Gt																																			
St.ON	St.Rt																																			
St.dt																																				
SC.Ad	SC.Md																																			
SC.bd	SC.OP																																			
SC.dL	SC.P																																			
SC.Id	SC.RS																																			

The USER Menu

Adjusts alarm setpoints, relay operation, and various sensor parameters such as gas type and display engineering units.

Displayed As:	Description	Min	Max	Default Value
USER MENU - Alarm Relay Parameters				
A1.SP	Alarm 1 Set Point - At this concentration the unit will turn on the AL1 display indicator and activate the associated alarm relay. Value must be equal or higher than A1.RP for rising alarm; value must be lower than A1.RP for oxygen (falling alarm),	(Sensor Dependent)		
A1.RP	Alarm 1 Reset Point - At this concentration the unit will turn off the AL1 display indicator and deactivate the alarm's relay. Value must be equal or lower than A1.SP for rising alarm; value must be higher than A1.SP for oxygen (falling alarm).	(Sensor Dependent)		
A1.Sd	Alarm 1 Set Delay in seconds. Delays activation of the alarm's display indicator and the alarm's relay after the concentration reaches to the alarm's set point value.	0	10	0
A1.Rd	Alarm 1 Reset Delay in seconds. Delays deactivation of the alarm's display indicator and the alarm's relay after the concentration reaches the alarm's reset point value.	0	9999	0
A1.OP	Alarm 1 Options - Specifies options for the alarm 1 indicator and relay. NONE = Non-latching, non-failsafe FSF = Non-latching, failsafe LAT = Latching, non-failsafe BOTH = Latching, fail-safe Failsafe energizes the alarm relay in the non-alarm state and de-energizes it on alarm (and power) failure. The latching option requires that the alarm indicator be manually reset and relatched, once the concentration has fallen to (or below) the alarm's set point value.	None	Both	None
A2.SP	Alarm 2 Set Point - See A1.SP for details.	0	9999	1
A2.RP	Alarm 2 Reset Point - See A1.RP for details.	0	9999	1
A2.Sd	Alarm 2 Set Delay in seconds. See A1.Sd for details.	0	10	1
A2.Rd	Alarm 2 Reset Delay in seconds. See A1.Rd for details.	0	9999	10
A2.OP	Alarm 2 Options - Specifies options for the alarm 2 indicator and relay. See A1.OP for details.	None	Both	None

Displayed As:	Description	Min	Max	Default Value
USER MENU - Alarm Relay Parameters				
AF.NL	Maximum Negative Drift Fault Alarm - At or below this concentration the unit will display the fault indicator, open the fault relay, and output the programmed milliamp fault level.	-999	9999	-10% FS
AF.OP	Fault Alarm Options - NONE = Non-latching, non-failsafe FSF = Non-latching, failsafe LAT = Latching, non-failsafe BOTH = Latching, failsafe The failsafe option keeps the relay energized in the non-alarm state and de-energizes it in alarm (and power failure). The latching option requires you to manually reset the fault indicator and relatch once the fault has cleared.	None	Both	FSF
AL.IP	Alarm Inhibit Period - Specifies the number of minutes which the alarm inhibit period will remain on before automatically timing out and re-enabling alarm relays.	0	90	9
AL.tO	Alarm Test Override - Used to test each alarm indicator and relay individually, or in groups (regardless of the alarm inhibit state). Activates alarm indicators and energizes non failsafe relays (de-energizes failsafe relays). Note that this test has no affect if the alarm is currently active and cannot be used to turn off an alarm. The state is reset to 0 at startup and is defined below: 0 - None 4 - Fault 1 - AL1 5 - AL1, Fault 2 - AL2 6 - AL2, Fault 3 - AL1, AL2 7 - AL1, AL2, Fault NOTE: To prevent false alarms at the receiver, set the receiver channel to alarm inhibit prior to making these adjustments.	0	7	0

Displayed As:	Description	Min	Max	Default Value
User Menu - Sensor Parameters				
SR.dC	Sensor Damping Constant - Specifies the damping time constant in seconds. This is the amount of time that it will take the unit to reach 63% of its final value when suddenly exposed to a known concentration of gas. The time to reach 95% of final value may be estimated by multiplying this setting by 3. This period does not include the time required to transport the gas to the sensor chamber.	0	60	2
SR.tC	Sensor Temperature in °C (Read Only)	-500	750	N/A
SR.tF	Sensor Temperature in °F (Read Only)	-580	1670	N/A
St.ON	Sensor Self-Test Enable (applies to instruments with the sensor self-test option) OFF - Automatic self-test is disabled. ON - Self test will occur at the times specified by St.t1, St.t2 and will repeat after the number of days specified by St.dt. NOW - Self test will occur immediately and return to its previous state (ON or OFF). TEST - Factory use only.	Off	Test	Off
St.dt	Sensor Self-Test Days Between Tests (applies to instruments with the sensor self-test option.) Specifies the number of days between tests.	1	60	1
St.t1	Sensor Self-Test Time-of-Day 1 (applies to instruments with the sensor self-test option). Specifies the time of day (hh.mm) when a sensor self-test sequence will occur. This date may be before, after, or equal to the St.t2 time. Note that the self-test will not occur at this time if a self-test is already in progress. Set equal to the St.t2 time if only one self test is desired.	00.00	23.59	06.00
St.t2	Sensor Self-Test Time-of-Day 2 (applies to instruments with the sensor self-test option). Specifies the time of day (hh.mm) when a sensor self-test sequence will occur. This date may be before, after, or equal to the St.t1 time. Note that the self-test will not occur at this time if a self-test is already in progress. Set equal to the St.t1 time if only one self test is desired.	00.00	23.59	18.00
St.Gt	Sensor Self-Test Gas Exposure Time (applies to instruments with the sensor self-test option). Specifies the maximum amount of time in seconds which gas will be delivered to the sensor in order to achieve a 10% full scale reading.	1	120	20
St.Rt	Sensor Self-Test Recovery Time (applies to instruments with the sensor self-test option). Specifies the maximum amount of time in seconds which the instrument will wait for readings to fall to 5% of full scale after the test is completed.	10	300	20

The LOCK Menu

Accesses the transmitter's security features.

LOCK MENU				
Displayed As:	Description	Min	Max	Default Value
LK.ON	Lock On/Off (Password Entry Required) - Entering the current password in this field toggles the lock status from On to Off, or from Off to On. The LCD lock icon is visible to indicate the transmitter is locked. Note that the transmitter can automatically re-lock when a non-zero value is entered under the LK.tM parameter.	0 (Off)	1 (On)	0 (Off)
LK.PW	Lock Password - The lock password is visible for changing only when the lock icon is not present on the LCD. The master password is 251 and will open the lock at any time.	000	999	000
LK.tM	Auto-Lock Time-Out - Specifies the number of minutes after which the transmitter will automatically re-lock. The period begins from the moment of toggling the lock off, and will not re-lock until resuming operation in RUN mode (will not auto-lock while reviewing or editing parameters). The feature is completely disabled by setting the parameter to 0.	0	90	0

The COMM Menu

Accesses the transmitter's loop current, report generator, and serial communication parameters.

Displayed As:	Description	Min	Max	Default Value
COMM MENU - Loop Current Parameters				
MA.04	4.00 mA Loop Cal Point - This value can be adjusted to drive precisely 4.00mA to calibrate the 0% concentration level, which can help overcome excessive wire/receiver loading. The value presented is the hexadecimal value that is written to the digital-to-analog converter (DAC). NOTE: There is a 5 second delay between the time the parameter is set and the time the output is seen by the receiving device.	0000 (hex)	FFFF (hex)	2AF8 (hex)
MA.20	20.0 mA Loop Cal Point - This value can be adjusted to drive precisely 20.0 mA at the full scale concentration level, which can help overcome excessive wire/receiver loading. The value presented is the hexadecimal value that is written to the digital-to-analog converter (DAC). NOTE: There is a 5 second delay between the time the parameter is set and the time the output is seen by the receiving device.	0000 (hex)	FFFF (hex)	d4d0 (hex)
MA.SF	4-20 mA Scale Factor - Can be used to scale the current loop output by a factor, effectively increasing or decreasing the full scale value. Normally should be left in the default value.	0.50	2.00	1.00
MA.F	4-20 mA Fault Level - Specifies the output in milliamps when the transmitter detects a fault condition.	1.500	4.000	1.500
MA.I	4-20 mA Inhibit Level - Specifies the output in milliamps when the transmitter is placed into an alarm inhibit condition.	1.500	20.00	3.100
MA.t	4-20 mA Test Level - Specifies the output in milliamps which is forced onto the current loop for test purposes (checking alarms at the receiver, etc.).	0.000	24.00	2.000

Displayed As:	Description	Min	Max	Default Value
COMM MENU - Report Generator Parameters				
RP.ON	<p>Report On/Off - Transmits an ASCII one line report on the serial communication interface to a printer, or to a host computer for data capture. Settings are: NONE - Reports disabled. TIME - Automatic. POLL - Must be prompted over serial communication. BOTH - Reports transmitted on timed interval or in response to poll.</p> <p>The report rate is determined by the RP.Pd parameter and the format of the report line is controlled by the RP.F1 thru RP.F8 parameters. Field delimiters and line termination strings are specified by the RP.d1 thru RP.d5 and RP.E1 thru RP.E5 parameters.</p>	None	Both	None
RP.Pd	<p>Report Period - When reports are enabled (RP.ON=ON), this parameter specifies the number of seconds between transmissions.</p>	0	7200	1
RP.d1 thru RP.d5	<p>Report Delimiter String - These parameters contain each character of the null terminated delimiter string which is printed between fields of the report line. The parameter value is the hexadecimal ASCII code representing a single character. RP.D1 contains the first character, followed by RP.d2, RP.d3, etc. The null terminated string may be up to 5 characters in length, ending with 0.</p> <p>Examples: (space): RP.d1=20, RP.d2 thru RP.d5=0 (comma): RP.d1=2C, RP.d2 thru RP.d5=0 (tab): RP.d1=09, RP.d2 thru RP.d5=0 (comma+space): RP.d1=20, RP.d2=2C, RP.d3 thru RP.d5=0</p>	0	255	RP.d1=20 RP.d2-d5= 00
RP.E1 thru RP.E5	<p>Report Line Termination String - These parameters contain each character of the null terminated delimiter string which is printed between fields of the report line. The parameter value is the hexadecimal ASCII code representing a single character. RP.E1 contains the first character, followed by RP.E2, RP.E3, etc. The null terminated string may be up to 5 characters in length., ending with 0.</p> <p>Examples: (carriage return): RP.E1=0d, RP.E2 thru RP.E5=0 (carriage return+line feed): RP.E1=0d, RP.E2=0A, RP.E3 thru RP.E5=0</p>	0	255	RP.E1=0d RP.E2=0A RP.E3=00

Displayed As:	Description	Min	Max	Default Value
COMM MENU - Report Generator Parameters (con't.)				
RP.F1 thru RP.F8	<p>Report Fields - Data may be printed in up to 8 fields in the form of a 1 line report. The data that is printed in each of the 8 fields is specified by setting an appropriate code in the RP.F1 - F8 parameters. The table below lists each code and the data that is printed when the code is used. Note that the first field printed is always the device ID (SC.Id). "SKIP" (blank) - Prints empty field. MD - Date (mm/dd) USA format (w/o year). Ex: 11/22 MDY - Date (mm/dd/yy) USA format (w/year). Ex: 11/22/97 DM - Date (dd/mm) European format (w/o year). Ex: 22/11 DMY - Date (dd/mm/yy) European format (w/year). Ex: 22/11/975 T12H - Time 12 hr. format with AM/PM. Ex: 2:15:05 PM T24H - Time 24 hr. Military format. Ex: 14:05:05 DEGC - Temperature (°C) 0.1 degree resolution. Ex: 25.0 DEGF - Temperature (°F) 0.1 degree resolution. Ex: 77.0 PCT - Gas (% FS). CONC - Gas (ppm, ppb, %v/v) STAT - Alarms (4 digit hex). SIGS - Sensor MV input, thermistor MV input. EOL - End of Line.</p>	SKIP	EOL	RP.F1=Mdy RP.F2=t24H RP.F3=dEGF RP.F4=CONC RP.F5=STAT RP.F6=EOL
Rt.dt	Real Time Clock (Date) - Used to set the internal real time clock date. Format: MM.dd. Example: 08.14	01.01	12.31	(set by factory)
Rt.YR	Real Time Clock (Year) - Used to set the internal real time clock year. A Note About Year 2000 Roll Over - The transmitter's is not controlled in any way by the internal clock which is used only for date recording during span adjustment and reports. Only two digits are maintained for the year dates which should not be reported over the serial communication.	1	99	99
Rt.tM	Real Time Clock (Hour) - Used to set the internal real time clock. Format HH.MM. Example: 09.30	00.00	23.59	(set by factory)

Displayed As:	Description	Min	Max	Default Value
COMM MENU - Serial Communication				
SC.Ad	(Device Address) - Specifies the address to which the instrument will respond to queries. This field also shows up in the first column printed by the report generator.	1	247	1
SC.bd	Serial Communication Baud Rate - Specifies the data communication baud rate: 110 4800 150 9600 300 19.2 k 600 31.2 k 1200 38.4 k 2400	110	38.4K	9600
SC.dL	Serial Communication Data Length - Specifies the number of data bits transmitted in each byte. 7 BIT 8 BIT	7BIT	8BIT	8 BIT
SC.Id	Serial Communication Idle - Specifies the number of idle characters (silent interval) that must be seen before recognition of the end of message (Modbus™ = 4). This can be used to adjust query/response synchronization on noisy data lines.	0	9999	4
SC.LO	Serial Communication Listen Only - Setting this parameter to 1 forces the transmitter to listen for and process Modbus™ queries (including broadcast), but without generating a response. OFF=listen and respond ON=listen only This parameter should normally be set to 0.	Off	On	Off
SC.Md	Serial Communication Mode - This parameter specifies which communication protocol to use: NONE = None ASC = ASCII Report Generator. MB =Modbus™ RTU.	None	MB	MB

Displayed As:	Description	Min	Max	Default Value
COMM MENU - Serial Communication (con't.)				
SC.OP	<p>Serial Communication Options - Only used in ASCII mode over RS-232 interface, this parameter controls whether the transmitter echoes every character sent, and if it expands outbound carriage returns to carriage return + line feed. SC.Md = ASC, SC.RS = 232 NONE = no echo, no CR expansion ECHO = echo, no CR expansion CRLF = no echo, expand CR to CR/LF BOTH = echo, expand CR to CR/LF</p>	None	Both	None
SC.P	<p>Serial Communication Parity Checking - Specifies whether parity checking is performed and generated. NONE =None ODD =Odd Parity EVEN =Even Parity</p>	None	Even	None
SC.RS	<p>Serial Communication RS-232/485 Selection - Specifies either RS-232 or RS-485 communication. When choosing RS-232, verify the jumpers at JP1 on the power supply board are cut and jumpered as shown in the electrical connections. Since RS-485 is the default, no modifications to JP1 are required. 232 = RS-232 Non-isolated 485 = RS-485 Non-isolated 485.I= RS-485 Isolated (currently not available)</p>	232	485.1	485
SC.Rt	<p>Serial Communication Retries - This parameter is not currently used.</p>	0	9999	10
SC.Sb	<p>Serial Communication Stop Bits -Specifies either 1 or 2 stop bits. 1=1 bit 2=2 bits</p>	1	2	1
SC.VF	<p>Serial Communication Verify - When set to ON, OFF, turns off CRC checking in Modbus™ RTU protocol.</p>	Off	On	On

The FACT Menu

FACT parameters are rarely used under "field" conditions. Typically these parameters are only used for troubleshooting and service issues.

Displayed As:	Description	Min	Max	Default Value
F.PWD	Factory Password Entry - Certain functions and parameters contained in the FACT menu are protected by a factory security password under the F.PWD. Each time the factory password is entered, security is disabled for period of 100 minutes (6000 seconds). Repeating the entry of the factory password will restart the timer at 100 minutes. During this time, the functions/parameters may be executed/updated. When the timer expires at zero, attempting to enter, execute, or modify values will result in a display of "ERR". Normal user security must be disabled before the factory password is accepted. Enabling or disabling factory security does not affect the display of the lock icon. The amount of time (in seconds) remaining until factory security is automatically re-enabled may be viewed under the F.tMR parameter.	000	999	000
F.tMR	Factory Security Timer Status in Seconds.	00.00	99.99	1
F.CAL	Factory Calibration Function - This function is used at the factory to calibrate the sensor millivolt input to 0.250 and 1.800 volts and should not be required in the field.	0	1	1
F.HtC	Factory High Temperature Calibration.	0	0	0
F.RES	<p>Factory Reset Memory. NONE = Resets the instrument. USER = Resets the following parameters to their default values: A1.SP, A1.RP, A1.Sd, A1.Rd, A1.OP, A2.SP, A2.Sd, A2.Rd, A2.OP, AF.NL, AF.OP, AL.IP, AL.tO, SR.dC, St.ON, St.Dt, St.t1, St.t2, St.Gt, St.Rt, LK.ON, LK.OW, LK.tM, MA.SF, MA.F, MA.I, MA.t, RP.ON, RP.Pd, RP.d1-5, RP.E1-5, RP.F1-8, SC.Ad, SC.bd, SC.dL, SC.Id, SC.LO, SC.Md, SC.OP, SC.P, SC.RS, SC.Rt, SC.Sb, SC.VF, F.LCd.</p> <p>SNSR = Copies slow sensor memory into fast processor memory and resets the following parameters to their default values: A1.SP, A1.RP, A2.SP, A2.RP, AF.NL.</p> <p>FACT = Resets the following parameters to their default values: LK.PW, LK.tM.</p> <p>NOTE 1: The input amplifier calibration is reset to default values. The amplifier should be recalibrated after this reset. This calibration should be done only by factory authorized personnel.</p> <p>NOTE 2: The current loop output calibration is reset to default values. Both the 4mA and 20mA calibrations should be performed after this reset. These calibrations may be performed in the field and are detailed earlier in this manual (see MA.04, MA.20).</p>	NONE	FACT	NONE

Displayed As:	Description	Min	Max	Default Value
FACT MENU - Parameters (continued...)				
F.MNt	Factory Maintenance - Displays the current value of the system maintenance code. Codes may be cleared to 0 by operator. 0 = No codes present. 1 = Calibration factor low (must recalibrate to clear) . 2 = Self-test aborted due to the presense of gas. Perform self-test (St.ON+NOW) or reset F.MNt value to 0.	0	2	0
F.ZMV	Sensor Zero Millivolt Value - Nominal value: 250	0	2500	Varies by Sensor
F.SCF	Sensor Span Calibration Factor - Nominal value: 1550	0	2500	Varies by Sensor
F.SMV	Sensor Span Millivolt Value - Nominal value: 1800	0	2500	Varies by Sensor
F.tCF	Sensor Temperature Compensation Factor - Nominal value.	0	5000	Varies by Sensor
F.LSd	Sensor Last Span Date - Nominal value.	01.01	12	Varies by Sensor
F.LSt	Sensor Last Span Time - Nominal value.	00.00	23.59	Varies by Sensor
F.SGC	Sensor Span Gas Concentration - Nominal value.	0	9999	Varies by Sensor
F.StC	Sensor Span Temperature in 0.1 °C - Nominal value: 250	-407	750	Varies by Sensor
F.tYP	Sensor Type (Model No.)	0	99	Varies by Sensor
F.RNG	Sensor Full Scale Range - This value is used in conjunction with F.dPG to specify the sensor full scale range. To determine the sensor full scasle range, multiply this value first by 10, then by the appropriate value shown for F.dPG.	1	9999	Varies by Sensor
F.dPG	Sensor Decimal Point in Gas Reading - Used to scaling the gas concentration reading, alarm set/reset points, negative drift limit, and span concentration during calibration. F.dPG multiply by: 0 1.0 1 0.1 2 0.01 3 0.001	0	3	Varies by Sensor

Displayed As:	Description	Min	Max	Default Value
FACT MENU - Parameters (continued...)				
F.GCU	Sensor Gas Concentration Units - ASCII character code (in hexadecimal) corresponding to the gas units of measure. PPM = 4d PPB = 42 PCT = 43	42 (hex)	4d (hex)	Varies by Sensor
F.SP1	Sensor Default Set Point 1 Value (low alarm) - This value is used in conjunction with F.dPG to specify the set point 1 value (low priority alarm). To determine the exact value, multiply by the appropriate scaler shown for F.dPG. (Do not attempt to change this value.)	1	9999	Varies by Sensor
F.SP2	Sensor Default Set Point 2 Value (high alarm) - This value is used in conjunction with F.dPG to specify the set point 2 value (high priority alarm). To determine the exact value, multiply by the appropriate scaler shown for F.dPG. (Do not attempt to change this value.)	1	9999	Varies by Sensor
F.MFG	Sensor Manufacturing Code - For internal use by factory.	0	9999	Varies by Sensor
F.SSN	Sensor Serial Number - For internal use by factory.	0	9999	Varies by Sensor
F.096	Sensor Part Number - For internal use by factory.	0	9999	Varies by Sensor
F.CS1	Sensor Memory Checksum 1 - Used for sensor memory integrity.	(hex) 0000	(hex) FFFF	Varies by Sensor
F.CS2	Sensor Memory Checksum 2 - Used for sensor memory integrity.	(hex) 0000	(hex) FFFF	Varies by Sensor
F.CS3	Sensor Memory Checksum 3 - Used for sensor memory integrity.	0000 (hex)	FFFF (hex)	Varies by Sensor
F.LbF	Last Byte in File - Used for sensor memory integrity.	(hex) 00	(hex) FF	Varies by Sensor
F.LCd	LCD Contrast Setting.	0	100	Varies by Sensor
SW.Id	Software Version Number (Read Only) - Used by factory.	1.000	10.00	Varies by Sensor

Troubleshooting

Fault Codes and Error Messages

When the transmitter detects a fault, the FAULT indicator appears on the display. The following also occurs, unless the transmitter is in inhibit mode (INHIBIT also visible on the display).

1. The fault relay de-energizes (unless AF.OP has been reprogrammed for non-fail-safe operation).
2. The current loop output is set to the programmed fault level (as set by MA.F).
3. If alarms were active at the time of the fault, they are latched until the fault is cleared, or the instrument is placed into inhibit mode.
4. New alarms are not recognized until the fault is corrected.
5. If the display is in RUN mode (not currently calibrating or editing setup parameters), the following message scrolls on the display. "CODE x x x x TOUCH THE ENTER KEY". Touching the magnet to the S/ENT key will cause the display to sequentially scroll an error message for each fault detected. Below is a list of error messages along with possible corrective actions.

ERROR MESSAGE	POSSIBLE CORRECTIVE ACTION
ROM-FAULT	Repair or replace CPU board.
RAM-FAULT	Repair or replace CPU board.
USER-MEM	Reset USER memory. Verify all parameter values and restore restore required settings.
FACT-MEM	Reset FACT memory. Perform F.CAL. Calibrate current loop.
SENSOR-MEM	Replace sensor.
LOW-POWER	Verify +18 to +28 VDC input at TB1 of PS board. Isolate problem to faulty board. Repair or replace board.
LCD-BUS	Display may be unreadable. Isolate problem to faulty board. Repair or replace board.
CLK-BUS	Isolate problem to faulty board. Repair or replace board.
SENSOR MISSING	Re-tighten sensor housing cap. Check sensor connections to board. Replace sensor or isolate problem to faulty board.
LOOP OPEN	Check current loop connections (refer to electrical wiring diagrams).
SPI-BUS	Repair or replace CPU board.
CPU-EE	Repair or replace CPU board.
NEG-DRIFT	Zero calibrate sensor.
GAS-SIG-LO GAS-SIG-HI TMP-SIG-LO TMP-SIG-HI	Replace sensor or isolate to faulty board, then repair or replace board. Retighten sensor housing cap.
SELF-TEST-FAIL	Verify self-test plug connections. Repair or replace sensor or self-test generator.
GAS-CAL-LOW	Replace sensor.
Required Procedures after Replacing Equipment	
SENSOR	Zero and span calibrate if necessary. If new sensor type, restore alarm set/reset points and all other required parameter settings.
CPU Board	Perform F.CAL and recalibrate current loop output. Restore alarm set/reset points and all other required parameter settings.
Power Supply Board	Perform F.CAL and recalibrate current loop output.
Display Board	Adjust LCD contrast if necessary.

Technical Specifications*

- Supply Voltage:** 18 to 28 VDC
- Operating Current**
 - With Relays:** 80 mA @ 18 VDC, 83 mA @ 24 VDC, 85 mA @ 30 VDC
 - Without Relays:** 54 mA @ 18 VDC, 50 mA @ 25 VDC, 48 mA @ 30 VDC
(Note: Reduce by 24 mA if powering current loop separately.)
- Repeatability:** ± 2 % FS
- Linearity:** ± 2 % FS
- Outputs:** 4-20 mA current loop, RS-232 or RS-485 (jumper/software selectable)
- 4-20 mA Loop Output:** 1.0 to 24.0 milliampere actual range
Isolated/Non-Isolated; Current Source/Sink
Drives 950 Ω of total load resistance @ 24 VDC (includes wiring)
Adjustable 4.00 and 20.0 output levels (to correct receivers)
Open current loop fault detection
- Optional Relays:** 2 SPST concentration relays and 1 SPST fail relay
Contacts rated at maximum of 5A @ 250 VAC or 30 VDC (resistive load).
Contacts rated at maximum of 2A @ 250 VAC or 30 VDC (inductive load).
- Display/Indicators:** LCD, 4 digits with decimal point, -999..9999
PPM, PPB, % V/V, °C, °F, AL1, AL2, FAULT, INHIBIT, MAINT and LOCK
- Magnetic Keys:** 4 total: UP (+), DOWN (-), S/ENT (Span/Enter), Z/ESC (Zero/Escape)
- Communications:** Modbus® RTU protocol and configurable ASCII report generator
- Diagnostics:** Missing sensor, current loop open (broken), electronic faults, configuration memory faults
- Operating Temperature:** -40°C to +65°C (transmitter only, does not apply to sensor)
- Humidity:** 99%RH maximum, non-condensing (limited by transmitter LCD) (electronic circuit boards protected by conformal coating)
- Weight:** 5 lbs (2.25 Kg)
- Separated Sensor:** May be remoted up to 50 feet from transmitter (optional).
- Approvals:** CSA (Certificate 1150551) - Class I, Zone 1, Group IIC; Ex d ib [ib] IIC T6
- Sensor Battery Life:** Nine months (unpowered)
- Warranties**
 - Transmitter:** 1 Year
 - Sensor:** 1 Year

*Subject to change without notice.

Contacting SCOTT HEALTH & SAFETY

4320 Goldmine Road
Monroe, NC 28110

Scott Health & Safety may be contacted
Monday through Friday

8:30 AM to 5:00 PM EST.

Phone 800-247-7257 • FAX 1-704-291-8340

e-mail • service@scotthealthsafety.com

Appendix 1

MODBUS® Register Addressing

Register Address	Description	Suggested Tag
40001	Function select register	FSR
40002	Parameter select register	PSR
40003-40006	Character data registers	CDR1 - CDR4
40007-40010	Integer data registers	IDR1 - IDR4
40011-40014	Long data registers	LDR1 - LDR2
40015-40018	Real data registers	RDR1 - RDR2
40019	Gas concentration (read only)	GAS
40021	Temperature (read only)	TMP
40023	Transmitter status (read only)	STS
40024	General fault status (read only)	GFS
40025	Sensor faults status (read only)	SFS
40026	Transmitter Type (read only)	TYP
40027	Loop Drive PWM (read only)	Lp - PWM

READ ONLY

Modbus® Register Data

The 4600 GasPlus(MB) transmitter implements the Modicon 884 PLC function set except for Function 18 (used to program the PLC). Readings and alarm information produced by the instrument are organized into 1 contiguous block so that the master can retrieve this data in 1 poll, rather than using several polls. This helps to increase the bandwidth of a network of transmitters. The transmitter's setup registers (parameters) are not organized for efficiency, since they should not need to be accessed on a regular interval.

Readings and Status Registers

REGISTER ADDRESS	DESCRIPTION	SUGGESTED TAG
------------------	-------------	---------------

40019	INTEGER	GAS
-------	---------	-----

Description - Gas concentration reading in PPM, PPB, or %V/V. This value must be multiplied by the decimal point multiplier at register 40020 (GAS_DP). The concentration units are indicated in STS register (see below). Range -999 to 9999.

40020	INTEGER	GAS_DP
-------	---------	--------

Description - Decimal point multiplier for the gas concentration reading at 40018 (GAS). Range 0 to 3.

Value	Multiply by...
0	1
1	0.1
2	0.01
3	0.001

REGISTER ADDRESS		DESCRIPTION	SUGGESTED TAG
40021		INTEGER	TMP
Description - Temperature reading on 0.1°C. Range - -400 to 750 (-40°C to +75.0°C). Multiply this value by 0.1 before using.			
40022		INTEGER	TMP_DP
Description - Decimal point multiplier for the temperature reading at 40021 (TMP). Fixed value of 1.			
40023		UNSIGNED INTEGER	STS
Description - Transmitter status word. Range 0 to 65535.			
High Byte	STON	LPO ALO RFF	LCK U2 U1 U0
Low Byte	IHB	MNT ALF AL2	AL2 RLF RL2 RL1
BIT 0	RL1	Alarm 1 relay status. 0=inactive, 1=active (see note below).	
BIT 1	RL2	Alarm 2 relay status. 0=inactive, 1=active (see note below).	
BIT 2	RLF	Fault relay status. 0=inactive, 1=active (see note below).	
BIT 3	AL1	AL1 display indicator status. 0=off, 1=on.	
BIT 4	AL2	AL2 display indicator status. 0=off, 1=on.	
BIT 5	ALF	FAULT display indicator status. 0=off, 1=on.	
BIT 6	MNT	MAINT display indicator status. 0=off, 1=on.	
BIT 7	IHB	INHIB display indicator status. 0=off, 1=on.	
BITS 8,9,10	U0,1,2	Displayed units indicator status:	
		<u>U2</u> <u>U1</u> <u>U0</u>	<u>Indicator</u>
		0 0 0	None
		0 0 1	°F (Fahrenheit)
		0 1 0	°C (Celsius)
		0 1 1	<reserved>
		1 0 0	%LEL (Lower Explosive limit)
		1 0 1	%V/V (Percent Volume per Volume)
		1 1 0	PPM (Parts Per Million)
		1 1 1	PPB (Parts Per Billion)
BIT 11	LCK	Lock display indicator status. 0=off, 1=on.	
BIT 12	RFF	Remote function fail indicator. 0=success, 1=failure.	
BIT 13	ALO	Alarm override status. 0=normal, 1=alarms overridden for test.	
BIT 14	LPO	Loop override status. 0=normal, 1=loop overridden for cal./test.	
BIT 15	STON	Sensor self-test status. 0=inactive, 1=self test in progress.	
40024		UNSIGNED INTEGER	GFS
Description - General fault status. Range 0 to 65535.			
High Byte	STON	LPO ALO RFF	LCK U2 U1 U0
Low Byte	IHB	MNT ALF AL2	AL2 RLF RL2 RL1
BIT 0	ROM	ROM fault.	
BIT 1	RAM	RAM fault.	
BIT 2	UMEM	User memory checksum fault.	
BIT 3	FMEM	Factory memory checksum fault.	
BIT 4	EMEM	External sensor shadow memory checksum fault.	

REGISTER ADDRESS	DESCRIPTION	SUGGESTED TAG
BIT 5	PWR	Low voltage fault.
BIT 6	LCD	LCD 12C bus fault.
BIT 7	IHB	Clock 12C bus fault.
BIT 8	EE24	External sensor 12C bus fault.
BIT 9	LOOP	Current loop open circuit fault.
BIT 10	SPI	Serial peripheral interface bus fault.
BIT 11	EE12	On chip EEPROM memory fault.
BIT 12	SNSR	Sensor fault detected (see SFS below).
BIT 13	NEG	Concentration below negative drift limit.
BIT 14	0	Not used.
BIT 15	OVR	Alarm or loop override detected (see STS above).
40025	UNSIGNED INTEGER	SFS
Description - Sensor status and faults. Range 0 to 512.		
High Byte (status):	0 0 0 0 0 0	NEW SCFLO
Low Byte (status):	0 0 0 STF TMPHI TMPLO SENHI SENLO	
BIT 0	SENLO	Sensor signal input below 0.012v.
BIT 1	SENHI	Sensor signal input above 2.488v.
BIT 2	TEMPLO	Temperature signal input too low.
BIT 3	TMPHI	Temperature signal input too high.
BIT 4	STF	Self-test failed to produce a sufficient signal input.
BIT 5-7		Not used - always 0.
BIT 8	NEW	New sensor detected, cleared automatically (not a fault).
BIT 9	LOOP	Span calibration factor low (sets MAINT indicator, not a fault).
BIT 10-15		Not used - always 0.
40027	UNSIGNED INTEGER	Lp -PWM
Description - 16 bit value representing PWM drive to loop circuit. Approximate calibration is 65535 counts = 24mA.		

Appendix 2 (FSR) Command Functions

Command functions are required whenever a value is to be *written* to the instrument. All command values are direct to the Function Select Register (FSR), located in address 40001. The FSR register recognizes 11 commands:

Command (1): Write 8-Bit byte parameter

Validates and writes 8-bit byte parameters into nonvolatile parameter memory. Updates the RFF bit in the STS register.

Sequence: CDR1={new value}, PSR={parameter#}, FSR=1

Command (2): Write 16-Bit integer parameter

Validates and writes 16-bit integer parameters into nonvolatile parameter memory. Updates the RFF bit in the STS register.

Sequence: IDR1={new value}, PSR={parameter#}, FSR=2

Command (10): Alarm Test Override

Turns on the alarm override mode and forces alarms to a specified state. Note that the alarm relays programmed as FAIL-SAFE will be energized when the alarm is OFF, and de-energized when the alarm is ON. Alarm override mode is disabled by using command Function 11 (Reset Alarms). This command does not affect the RFF bit in the STS register.

Register sequence (for forcing on/off more than one alarm at a time):

1. CDR1={0-7 [see table below]}
2. PSR=not used
3. FSR=10

CDR1	AL1	AL2	FAULT
0	OFF	OFF	OFF
1	ON	OFF	OFF
2	OFF	ON	OFF
3	ON	ON	OFF
4	OFF	OFF	ON
5	ON	OFF	ON
6	OFF	ON	ON
7	ON	ON	ON

Application Note:

When implementing the Alarm Test command (10), be sure to include the Alarm Reset command (11). For example, in a graphical user interface this might mean creating a "test" and "reset" button for each alarm. (i.e., pushing alarm 1 "test" button executes CDR1B0=1, FSR=10)

Command (11): Reset Alarms

Turns off the alarm override mode and clears the specified latched alarms. Any alarms currently forced on or off by command 10 will return to normal program control. This command may also be used in normal operation to manually reset latched alarm 1 or alarm 2, but only after alarm conditions have subsided. This function does not affect the RFF bit in the STS register.

Register sequence:

1. CDR1=0-4 (see table below)
2. PSR=not used
3. FSR=11

CDR1	AL1	AL2
0	No Change	No Change
1	Reset	No Change
2	No Change	Reset
3	Reset	Reset

See application note in Command 10.

Command (12): Set/Clear inhibit mode

Sequence: IDR1 = 1; FSR = 12 will force the instrument in Inhibit mode
 IDR1 = 0; FSR = 12 will clear the instrument Inhibit mode

To set (or change) the Inhibit mode timeout period (AL.IP) perform the following:
 IDR1 = desired period in minutes. Be careful, since there is no limit checking on the value.

PSR = 16;
 FSR = 2.

Example: Set the Inhibit period to timeout in 6 minutes. IDR1 = 6, PSR = 16, FSR = 2.
 To verify, read location 40297 (refer to Appendix 3).

Command (20): Zero-calibrate sensor

Sets the transmitter's zero point. Does not use PSR or data registers. Care must be taken to ensure that clean, zero-grade air is present at the sensor. Updates the RFF bit in the STS register.

FSR=20

Command (21): Span-calibrate sensor

Apply gas to sensor.

IDR1=conc

FSR=21

Command (22): Force Sensor Self-Test

IDR1=2

FSR=22

Command (30): Update real-time clock date

Synchronizes instrument date to host date. Does not use PSR register. Updates the RFF bit in the STS register.

Sequence:**CDR1=0-99 (2 digit year)****CDR2=1-12 (month)****CDR3=1-31 (day)****FSR=30****Command (31): Update real-time clock time**

Synchronizes instrument time (military time) to host time. Does not use the PSR register. Updates the RFF bit in the STS register.

Sequence:**CDR1=0-23 (hours)****CDR2=1-59 (minutes)****CDR3=1-59 (seconds)****FSR=31****Command (40): Toggle password security on/off**

Uses the password stored in IDR1 to toggle security on/off. Note that if the password is incorrect, this function will not be successful. Updates both the RFF and LCK bits in the STS register.

Sequence: FSR=40

Appendix 3

Modbus® Register Table

Label	Suggested Tag	Type	Reg.	Min	Max	D-reg	PSR	FSR	Comments
*	fsr	INT	40001	0	65535				Function Selection Register
*	psr	INT	40002	0	65535				Parameter Selection Register
*	cdr1	INT	40003	0	255				Character Parameter Data
*	cdr2	INT	40004	0	255				Character Parameter Data
*	cdr3	INT	40005	0	255				Character Parameter Data
*	cdr4	INT	40006	0	255				Character Parameter Data
*	idr1	INT	40007	-32768	32767				Integer Parameter Data
*	idr2	INT	40008	-32768	32767				Integer Parameter Data
*	idr3	INT	40009	-32768	32767				Integer Parameter Data
*	idr4	INT	40010	-32768	32767				Integer Parameter Data
**	gas	INT	40019	-32768	32767				Computed Gas Concentration in Either PPM,PPB,or%V/V
**	gas_dp	INT	40020	0	2				Gas Conc Multiplier: 0=1,1=0.1,2=0.01,3=0.001
**	tmp	INT	40021	-32768	32767				Reported Temperature in °C
**	tmp_dp	INT	40022	0	2				Temperature Multiplier 0=1,1=0.1,2=0.01,3=0.001
**	status	UINT	40023	0	65535				System Indicator/Relay Status
**	sys_gen_faults	UINT	40024	0	65535				System Fault Status
**	sensor_faults	UINT	40025	0	65535				Sensor Fault Status
**	transmitter_type	UINT	40026	0	65535				Transmitter Type:4600 or 4688 (read before accessing other data)
A1.SP	sp1	INT	40281	-32768	32767	idr1	4	2	Alarm Set Point 1 Value (sensor dependent, use gas_dp multiplier)
A2.SP	sp2	INT	40283	-32768	32767	idr1	9	2	Alarm Set Point 2 Value (sensor dependent, use gas_dp multiplier)
A1.RP	rp1	INT	40285	-32768	32767	idr1	5	2	Alarm Reset Point 1 Value (sensor dependent, use gas_dp multiplier)
A2.RP	rp2	INT	40287	-32768	32767	idr1	10	2	Alarm Reset Point 2 Value (sensor dependent, use gas_dp multiplier)
A1.SD	setdly1	UINT	40289	0	10	idr1	6	2	AL1 Delay on Set Option (in seconds)
A2.SD	setdly2	UINT	40290	0	10	idr1	11	2	AL2 Delay on Set Option (in seconds)
A1.RD	rstdly1	UINT	40292	0	9999	idr1	7	2	AL1 Delay on Reset Option (in seconds)
A2.RD	rstdly2	UINT	40293	0	9999	idr1	12	2	AL2 Delay on Reset Option (in seconds)
AF.NL	neglim	INT	40295	-32768	32767	idr1	14	2	Negative Drift Limit (sensor dependent)
AL.IP	alm_ihbpd	UINT	40297	0	90	idr1	16	2	Alarm Inhibit Period in Minutes
A1.OP	alm1_opts	UINT	40298	0	3	idr1	8	2	AL1 Options: 0=None,1=Fail-safe,2=Latching,3=Both
A2.OP	alm2_opts	UINT	40299	0	3	idr1	13	2	AL2 Options: 0=None,1=Fail-safe,2=Latching,3=Both
AF.OP	almF_opts	UINT	40300	0	3	idr1	15	2	FAULT Options: 0=None,1=Fail-safe,2=Latching,3=Both

*Used during parameter update only.

**Organized for efficient block read (read only).

Label	Suggested Tag	Type	Reg.	Min	Max	D-reg	PSR	FSR	Comments
SC.AD	comm_addr	UINT	40301	1	247	idr1	59	2	Serial Comm Instrument Address
SC.BD	comm_baud	UINT	40302	0	10	idr1	60	2	Serial Comm Baud: 10=38.4k,9=19.2k,8=14.4k,7=9600...0=110
SC.DL	comm_data	UINT	40303	0	1	idr1	61	2	Serial Comm Data Length: 0=7,1=8
SC.ID	comm_idle	UINT	40305	0	9999	idr1	62	2	Serial Comm Number of Idles Between Messages
SC.LO	comm_listen	UINT	40306	0	1	idr1	63	2	Serial Comm Listen Only: 0=Listen and Talk,1=Listen Only
SC.MD	comm_mode	UINT	40307	0	2	idr1	64	2	Serial Comm Mode: 0=None,1=ASCII,2=Modbus™ RTU
SC.OP	comm_opts	UINT	40308	0	3	idr1	65	2	See Definitions Above
SC.P	comm_parity	UINT	40309	0	2	idr1	66	2	Serial Comm Parity: 0=None, 1=Even, 2=Odd
SC.RS	comm_eia	UINT	40310	0	2	idr1	67	2	Serial Comm Interface: 0=RS-232,1=RS-485
SC.RT	comm_retries	UINT	40311	0	9999	idr1	68	2	Serial Comm Printer Busy Retries
SC.SB	comm_stop	UINT	40312	1	2	idr1	69	2	Serial Comm Number of Stop Bits
SC.VF	comm_verify	UINT	40313	0	1	idr1	70	2	Serial Comm Verify: 0=No LRC/CRC Verification,1=Normal
RP.F1	rep_field1	INT	40314	0	13	idr1	48	2	Field 1: 0:SKIP,1:MD,2:MDY,3:DM,4:DMY,5:T12H,6:T24H,7:DEGF,8:DEGC,9:PCT,10:CONC,11:STAT,12:SIG,13:EOL
RP.F2	rep_field2	INT	40315	0	13	idr1	49	2	Field 2: 0:SKIP,1:MD,2:MDY,3:DM,4:DMY,5:T12H,6:T24H,7:DEGF,8:DEGC,9:PCT,10:CONC,11:STAT,12:SIG,13:EOL
RP.F3	rep_field3	INT	40316	0	13	idr1	50	2	Field 3: 0:SKIP,1:MD,2:MDY,3:DM,4:DMY,5:T12H,6:T24H,7:DEGF,8:DEGC,9:PCT,10:CONC,11:STAT,12:SIG,13:EOL
RP.F4	rep_field4	INT	40317	0	13	idr1	51	2	Field 4: 0:SKIP,1:MD,2:MDY,3:DM,4:DMY,5:T12H,6:T24H,7:DEGF,8:DEGC,9:PCT,10:CONC,11:STAT,12:SIG,13:EOL
RP.F5	rep_field5	INT	40318	0	13	idr1	52	2	Field 5: 0:SKIP,1:MD,2:MDY,3:DM,4:DMY,5:T12H,6:T24H,7:DEGF,8:DEGC,9:PCT,10:CONC,11:STAT,12:SIG,13:EOL
RP.F6	rep_field6	INT	40319	0	13	idr1	53	2	Field 6: 0:SKIP,1:MD,2:MDY,3:DM,4:DMY,5:T12H,6:T24H,7:DEGF,8:DEGC,9:PCT,10:CONC,11:STAT,12:SIG,13:EOL
RP.F7	rep_field7	INT	40320	0	13	idr1	54	2	Field 7: 0:SKIP,1:MD,2:MDY,3:DM,4:DMY,5:T12H,6:T24H,7:DEGF,8:DEGC,9:PCT,10:CONC,11:STAT,12:SIG,13:EOL
RP.F8	rep_field8	INT	40321	0	13	idr1	55	2	Field 8: 0:SKIP,1:MD,2:MDY,3:DM,4:DMY,5:T12H,6:T24H,7:DEGF,8:DEGC,9:PCT,10:CONC,11:STAT,12:SIG,13:EOL
RP.D1	rep_delim_1	CHAR	40324	0	255	cdr1	38	1	1st Char of Field Delimiter String, 0 will terminate string
RP.D2	rep_delim_2	CHAR	40325	0	255	cdr1	39	1	2nd Char of Field Delimiter String, 0 will terminate string
RP.D3	rep_delim_3	CHAR	40325	0	255	cdr1	40	1	3rd Char of Field Delimiter String, 0 will terminate string
RP.D4	rep_delim_4	CHAR	40326	0	255	cdr1	41	1	4th Char of Field Delimiter String, 0 will terminate string
RP.D5	rep_delim_5	CHAR	40326	0	255	cdr1	42	1	5th char of field delimiter string, 0 will terminate string
RP.E1	rep_eol_1	CHAR	40327	0	255	cdr1	43	1	1st Char of End of Line String, 0 will terminate string
RP.E2	rep_eol_2	CHAR	40328	0	255	cdr1	44	1	2nd Char of End of Line String, 0 will terminate string
RP.E3	rep_eol_3	CHAR	40328	0	255	cdr1	45	1	3rd Char of End of Line String, 0 will terminate string
RP.E4	rep_eol_4	CHAR	40329	0	255	cdr1	46	1	4th Char of End of Line String, 0 will terminate string
RP.E5	rep_eol_5	CHAR	40329	0	255	cdr1	47	1	5th Char of End of Line String, 0 will terminate string
RP.PD	rep_period	UINT	40330	0	7200	idr1	37	2	Seconds Between Reports when rep_mode=1 (TIME)
MA.I	inhibit_uA	INT	40349	1500	20000	idr1	34	2	uA Output During Alarm Inhibit Indication (mA*1000)
MA.T	test_uA	INT	40351	0	24000	idr1	35	2	uA Output During Test (must use special command to override output)
MA.SF	ma_scaler	UINT	40353	50	2000	idr1	32	2	Scale Factor Applied to the Loop Output in % (50=0.50, 200=2.00)

Record Your Parameters !

Parameter Label	Transmitter #
A1.SP	
A1.RP	
A1.Sd	
A1.Rd	
A1.OP	
A2.SP	
A2.RP	
A2.Sd	
A2.Rd	
A2.OP	
AF.NL	
AF.OP	
AL.IP	
AL.tO	
SR.dC	
SR.dP	
SR.dP	
SR.tF	
St.ON	
St.dt	
St.t1	
St.t2	
St.Gt	
St.Rt	
LK.ON	
LK.PW	
LK.TM	
MA.04	
MA.20	
MA.SF	
MA.F	
MA.I	
MA.t	
RP.ON	
RP.Pd	
RP.d1-RP.d5	
RP.E1-RP.E5	
RP.F1-RP.F8	
Rt.dt	
Rt.YR	
Rt.tM	

NOTES:

Record Your Parameters ! (Con't.)

NOTES:

Parameter Label	Transmitter #
SC.Ad	
SC. Bd	
SC.dL	
SC.Id	
SC.LO	
SC.Md	
SC.OP	
SC.P	
SC.RS	
SC.Rt	
SC.Sb	
SC.VF	
F.PWd	
F.tMR	
F.CAL	
F.HtC	
F.RES	
F.MNt	
F.ZMV	
F.SCF	
F.SMV	
F.tCF	
F.LSd	
F.LSt	
F.SGC	
F.StC	
F.Typ	
F.RNG	
F.dPG	
F.GCU	
F.SP1	
F.SP2	
F.MFG	
F.SSN	
F.096	
F.CS1	
F.CS2	
F.CS2	
F.LbF	
F.LCd	
SW.1d	

Warranty

The manufacturer Scott Health & Safety, warrants to the original purchaser and/or ultimate customer of the manufacturer's products, that if any part(s) thereof (except for those listed below) proves to be defective in material or workmanship within 18 months from the date of shipment or 12 months from the date of start-up, whichever comes first. Such defective part(s) will be repaired or replaced free of charge if shipped prepaid to the factory in a package equal to (or) original container.

All products will be returned freight prepaid to user when determined by the manufacturer that the part(s) failed due to defective materials or workmanship.

The seller assumes no liability for consequential damages of any kind, and the buyer by acceptance of this equipment will assume all liability for the consequences of its use or misuse by the buyer, its employees, or others. A defect within the meaning of this warranty in any part of any piece of equipment shall not, when such part is capable of being renewed, repaired, or replaced, operate to condemn such piece of equipment.

This warranty does not cover consumable items, batteries, or wear items subject to periodic replacement.

This warranty is in lieu of all other warranties (including without limiting the generality of the foregoing warranties of merchantability and fitness for a particular purpose), guarantees, obligations, or liabilities expressed or implied by the seller or its representatives and by the statute or rule of law.

This warranty is void if the instrument has been subject to misuse or abuse, or has not been operated in accordance with instructions, or if the serial number has been removed.

SCOTT HEALTH & SAFETY MAKES NO OTHER WARRANTY EXPRESSED OR IMPLIED EXCEPT AS STATED ABOVE.

Statement of Year 2000 Compliance

The Model 4600 GasPlus(MB) accepts all dates in the years after 1999 as valid dates. Its functionality, performance, and accuracy will not be affected as a result of the run date or the dates being processed, irrespective of the century. When maintenance is performed on the product and/or the product is restarted after power has been removed, the system dates will remain correct to the actual date even if this date is on or later than the 1 January 2000.

Caution: This instrument stores its year data as a value from 00 to 99 (2 digits). It is recommended that this data is not accessed via the digital interface.

Spare Parts

Call 800-247-7257 or Your Local Sales Representative

Sensors

<p>Ammonia (NH₃) Model 85</p> <p>8-Digit Prefix Suffix # 096-1965 (XXXX)</p> <p>50 PPM -0050 100 PPM -0100* 150 PPM -0150 250 PPM -0250 500 PPM -0500</p> <hr/> <p>Arsine (AsH₃) Model 65</p> <p>8-Digit Prefix Suffix # 096-1953 (XXXX)</p> <p>1000 PPB -1000* 3 PPM -0003 10 PPM -0010</p> <hr/> <p>Boron Trichloride (BCl₃) <i>Order HCl sensor</i></p> <hr/> <p>Bromine (Br₂) Model 61</p> <p>8-Digit Prefix Suffix # 096-1949 (XXXX)</p> <p>1 PPM -0001* 3 PPM -0003 5 PPM -0005 10 PPM -0010 15 PPM -0015 25 PPM -0025 30 PPM -0030 50 PPM -0050 100 PPM -0100</p> <hr/> <p>Carbon Monoxide (CO) Model 82</p> <p>8-Digit Prefix Suffix # 096-1962 (-XXXX)</p> <p>50 PPM -0050 100 PPM -0100* 150 PPM -0150 200 PPM -0200 250 PPM -0250 300 PPM -0300 500 PPM -0500 1000 PPM -1000</p> <hr/> <p>Chlorine Oxidant (Cl₂) Model 52OX</p> <p>8-Digit Prefix Suffix # 096-2003 (-XXXX)</p> <p>1 PPM -0001 3 PPM -0003 5 PPM -0005* 10 PPM -0010</p>	<p>Chlorine (Cl₂) Model 52</p> <p>Standard % RH</p> <p>8-Digit Prefix Suffix # 096-1945 (-XXXX)</p> <p>1 PPM -0001 3 PPM -0003 5 PPM -0005* 10 PPM -0010 15 PPM -0015 25 PPM -0025 30 PPM -0030 50 PPM -0050 100 PPM -0100 200 PPM -0200</p> <hr/> <p>Chlorine (Cl₂) Low Humidity (<35%) Model 56</p> <p>8-Digit Prefix Suffix # 096-2257 (-XXXX)</p> <p>1 PPM -0001 3 PPM -0003 5 PPM -0005* 10 PPM -0010 15 PPM -0015 25 PPM -0025 30 PPM -0030 50 PPM -0050 100 PPM -0100 200 PPM -0200</p> <hr/> <p>Chlorine Dioxide (ClO₂) Model 53</p> <p>8-Digit Prefix Suffix # 096-1946 (-XXXX)</p> <p>1 PPM -0001* 3 PPM -0003 5 PPM -0005 10 PPM -0010 15 PPM -0015 25 PPM -0025 30 PPM -0030 50 PPM -0050 100 PPM -0100</p> <hr/> <p>Dichlorosilane (SiH₂Cl₂) <i>Order HCl sensor</i></p> <hr/> <p>Diborane (B₂H₆) Model 67</p> <p>8-Digit Prefix Suffix # 096-1955 (-XXXX)</p> <p>1000 PPB -1000* 2 PPM -0002 10 PPM -0010</p>	<p>Fluorine (F₂) Model 62</p> <p>8-Digit Prefix Suffix # 096-1950 (-XXXX)</p> <p>1 PPM -0001* 3 PPM -0003 5 PPM -0005 10 PPM -0010 15 PPM -0015 25 PPM -0025 30 PPM -0030 50 PPM -0050 100 PPM -0100</p> <hr/> <p>Germane (GeH₄) Model 69</p> <p>8-Digit Prefix Suffix # 096-1957 (-XXXX)</p> <p>1000 PPB -1000* 3 PPM -0003 10 PPM -0010</p> <hr/> <p>Hydrogen (H₂) Model 87</p> <p>8-Digit Prefix Suffix # 096-1967 (-XXXX)</p> <p>1% -0001 4% -0004* 5% -0005 10% -0010</p> <hr/> <p>Hydrogen Chloride (HCl) Low Humidity (<50%) Model 54</p> <p>8-Digit Prefix Suffix # 096-1947 (-XXXX)</p> <p>10 PPM -0010 25 PPM -0025* 50 PPM -0050 100 PPM -0100</p> <hr/> <p>Hydrogen Chloride (HCl) High Humidity (>50%) Model 71</p> <p>8-Digit Prefix Suffix # 096-1958 (-XXXX)</p> <p>10 PPM -0010 25 PPM -0025* 50 PPM -0050 100 PPM -0100</p>	<p>Hydrogen Cyanide (HCN) Model 64</p> <p>8-Digit Prefix Suffix # 096-1952 (-XXXX)</p> <p>10 PPM -0010 25 PPM -0025* 30 PPM -0030 50 PPM -0050 100 PPM -0100</p> <hr/> <p>Hydrogen Fluoride (HF) Lo %RH (<75%) Model 63</p> <p>8-Digit Prefix Suffix # 096-1951 (-XXXX)</p> <p>10 PPM -0010* 15 PPM -0015 25 PPM -0025 50 PPM -0050 100 PPM -0100</p> <hr/> <p>Hydrogen Fluoride (HF) Hi %RH (>75%) Model 70</p> <p>8-Digit Prefix Suffix # 096-2185 (-XXXX)</p> <p>10 PPM -0010* 25 PPM -0025 50 PPM -0050 100 PPM -0100</p> <hr/> <p>Hydrogen Selenide (H₂Se) Model 89</p> <p>8-Digit Prefix Suffix # 096-1968 (-XXXX)</p> <p>1000 PPB -1000* 10 PPM -0010</p> <hr/> <p>Hydrogen Sulfide (H₂S) High Humidity (>50%) Model 81</p> <p>8-Digit Prefix Suffix # 096-1961 (-XXXX)</p> <p>10 PPM -0010 25 PPM -0025 50 PPM -0050* 100 PPM -0100 200 PPM -0200</p> <hr/> <p>Hydrogen Sulfide (H₂S) Low Hum (<50%) Model 72</p> <p>8-Digit Prefix Suffix # 096-1959 (-XXXX)</p> <p>10 PPM -0010 25 PPM -0025 50 PPM -0050* 100 PPM -0100 200 PPM -0200</p>
---	--	--	---

Call 800-247-7257 or Your Local
Sales Representative

Sensors

<p>Methyl Hydrazine (MMH) Model 35</p> <p>8-Digit Prefix Suffix # 096-2423 (-xxxx) 50 PPM -0050</p>	<p>Nitrogen Trifluoride(NF₃) Model 33P</p> <p>8-Digit Prefix Suffix # 096-2099 (-XXXX) 10 PPM -0010* 20 PPM -0020</p>	<p>Sulfur Dioxide (SO₂) Model 83</p> <p>8-Digit Prefix Suffix # 096-1963 (-XXXX) 10 PPM -0010* 15 PPM -0015 25 PPM -0025 50 PPM -0050 100 PPM -0100 200 PPM -0200 500 PPM -0500</p>
<p>Methanol (CH₃OH) Model 59</p> <p>8-Digit Prefix Suffix # 096-2148 (-xxxx) 500 PPM -0500</p>	<p>Ozone(O₃) Model 60</p> <p>8-Digit Prefix Suffix # 096-1948 (-XXXX) 1 PPM -0001* 2 PPM -0002 3 PPM -0003 5 PPM -0005 10 PPM -0010 15 PPM -0015 25 PPM -0025 30 PPM -0030 50 PPM -0050 100 PPM -0100</p>	<p>Sulfur Dioxide (SO₂) Low Humidity Model 75</p> <p>8-Digit Prefix Suffix # 096-2359 (-XXXX) 10 PPM -0010* 15 PPM -0015 25 PPM -0025 50 PPM -0050 100 PPM -0100 200 PPM -0200 500 PPM -0500</p>
<p>Methyl Iodide (CH₃I) Model 44</p> <p>8-Digit Prefix Suffix # 096-2188 (-xxxx) 25 PPM -0025 1000 PPM -1000</p>	<p>Oxygen (O₂) Model 80</p> <p>8-Digit Prefix Suffix # 096-1960 (-XXXX) 10 % -0010 25 % -0025*</p>	<p>TEOS Model 58</p> <p>8-Digit Prefix Suffix # 096-2381 (-XXXX) 50 PPM -0050</p>
<p>Methylene Chloride (CH₂Cl₂) Model # 34(P)</p> <p>8-Digit Prefix Suffix # 096-2189 (-XXXX) 200 PPM -0200</p>	<p>Phosgene (COCl₂) Model 49</p> <p>8-Digit Prefix Suffix # 096-2235 (-xxxx) 1 PPM -0001</p>	<p>Vinyl Chloride Monomer (VCM) Model 73</p> <p>Part Number # 096-2404 20 PPM</p>
<p>Methyl Mercaptan (CH₃SH) w/ Filter Model 45</p> <p>8-Digit Prefix Suffix # 096-2348 (-xxxx) 5 PPM -0005</p>	<p>Phosgene (COCl₂) w/Filter Model 50</p> <p>8-Digit Prefix Suffix # 096-2235 (-xxxx) 2 PPM -0002</p>	<p>Vinyl Chloride Monomer (VCM) Model 73</p> <p>Part Number # 096-2441 1000 PPM</p>
<p>Methyl Mercaptan (CH₃SH) Model 46</p> <p>8-Digit Prefix Suffix # 096-2348 (-xxxx) 3 PPM -0003</p>	<p>Phosphine (PH₃) Model 66</p> <p>8-Digit Prefix Suffix # 096-1954 (-XXXX) 1000 PPB -1000* 3 PPM -0003 10 PPM -0010</p>	<p>Silane (SiH₄) Model 68</p> <p>8-Digit Prefix Suffix # 096-1956 (-XXXX) 1000 PPB -1000 10 PPM -0010*</p>
<p>Nitric Oxide (NO) Model 86</p> <p>8-Digit Prefix Suffix # 096-1966 (-XXXX) 25 PPM -0025 50 PPM -0050* 100 PPM -0100 500 PPM -0500</p>	<p>Nitrogen Dioxide (NO₂) Model 84</p> <p>8-Digit Prefix Suffix # 096-1964 (-XXXX) 10 PPM -0010* 25 PPM -0025 50 PPM -0050 100 PPM -0100 250 PPM -0250</p>	

Call 800-247-7257 or Your Local Sales Representative

Rock Solid Sensors

<p>Bromine (Br₂) Low Humidity Model 98</p> <p>8-Digit Prefix .. Suffix # 096-2366 (-XXXX)</p> <p>1 PPM -0001* 3 PPM -0003 5 PPM -0005 10 PPM -0010 15 PPM -0015 20 PPM -0020 25 PPM -0025 30 PPM -0030</p>	<p>R.S. Chlorine Dioxide (ClO₂) Low Humidity Model 57</p> <p>8-Digit Prefix .. Suffix # 096-2283 (-XXXX)</p> <p>1 PPM -0001* 3 PPM -0003 5 PPM -0005 10 PPM -0010 15 PPM -0015 20 PPM -0020 25 PPM -0025 30 PPM -0030</p>	<p>R.S. Hydrogen Chloride (HCl) Low Humidity Model 92</p> <p>8-Digit Prefix .. Suffix # 096-2332 (-XXXX)</p> <p>1 PPM -0001 3 PPM -0003 5 PPM -0005 10 PPM -0010 15 PPM -0015 20 PPM -0020 25 PPM -0025* 30 PPM -0030</p>	<p>R.S. Ozone (O₃) Low Humidity Model 76</p> <p>8-Digit Prefix .. Suffix # 096-2377 (-XXXX)</p> <p>1 PPM -0001* 3 PPM -0003 5 PPM -0005 10 PPM -0010 15 PPM -0015 20 PPM -0020 25 PPM -0025 30 PPM -0030</p>
<p>R.S. Bromine (Br₂) High Humidity Model 99</p> <p>8-Digit Prefix .. Suffix # 096-2367 (-XXXX)</p> <p>1 PPM -0001* 3 PPM -0003 5 PPM -0005 10 PPM -0010 15 PPM -0015 20 PPM -0020 25 PPM -0025 30 PPM -0030</p>	<p>R.S. Chlorine Dioxide (ClO₂) High Humidity Model 78</p> <p>8-Digit Prefix .. Suffix # 096-2315 (-XXXX)</p> <p>1 PPM -0001* 3 PPM -0003 5 PPM -0005 10 PPM -0010 15 PPM -0015 20 PPM -0020 25 PPM -0025 30 PPM -0030</p>	<p>R.S. Hydrogen Chloride (HCl) High Humidity Model 93</p> <p>8-Digit Prefix .. Suffix # 096-2333 (-XXXX)</p> <p>1 PPM -0001 3 PPM -0003 5 PPM -0005 10 PPM -0010 15 PPM -0015 20 PPM -0020 25 PPM -0025* 30 PPM -0030</p>	<p>R.S. Ozone (O₃) High Humidity Model 77</p> <p>8-Digit Prefix .. Suffix # 096-2378 (-XXXX)</p> <p>1 PPM -0001* 3 PPM -0003 5 PPM -0005 10 PPM -0010 15 PPM -0015 20 PPM -0020 25 PPM -0025 30 PPM -0030</p>
<p>R.S. Chlorine (Cl₂) Low Humidity Model 22</p> <p>8-Digit Prefix .. Suffix # 096-2247 (-XXXX)</p> <p>1 PPM -0001 3 PPM -0003 5 PPM -0005* 10 PPM -0010 15 PPM -0015 20 PPM -0020 25 PPM -0025 30 PPM -0030</p>	<p>R.S. Hydrogen Bromide (HBr) Low Humidity Model 94</p> <p>8-Digit Prefix .. Suffix # 096-2334 (-XXXX)</p> <p>1 PPM -0001 3 PPM -0003 5 PPM -0005* 10 PPM -0010 15 PPM -0015 20 PPM -0020 25 PPM -0025 30 PPM -0030</p>	<p>R.S. Hydrogen Fluoride (HF) Low Humidity Model 90</p> <p>8-Digit Prefix .. Suffix # 096-2330 (-XXXX)</p> <p>1 PPM -0001 3 PPM -0003 5 PPM -0005 10 PPM -0010* 15 PPM -0015 20 PPM -0020 25 PPM -0025 30 PPM -0030</p>	<p>R.S. Sulfur Dioxide (SO₂) Low Humidity Model 96</p> <p>8-Digit Prefix .. Suffix # 096-2336 (-XXXX)</p> <p>1 PPM -0001 3 PPM -0003 5 PPM -0005 10 PPM -0010* 15 PPM -0015 20 PPM -0020 25 PPM -0025 30 PPM -0030</p>
<p>R.S. Chlorine (Cl₂) High Humidity Model 24</p> <p>8-Digit Prefix .. Suffix # 096-2295 (-XXXX)</p> <p>1 PPM -0001 3 PPM -0003 5 PPM -0005* 10 PPM -0010 15 PPM -0015 20 PPM -0020 25 PPM -0025 30 PPM -0030</p>	<p>R.S. Hydrogen Bromide (HBr) High Humidity Model 95</p> <p>8-Digit Prefix .. Suffix # 096-2335 (-XXXX)</p> <p>1 PPM -0001 3 PPM -0003 5 PPM -0005* 10 PPM -0010 15 PPM -0015 20 PPM -0020 25 PPM -0025 30 PPM -0030</p>	<p>R.S. Hydrogen Fluoride (HF) High Humidity Model 91</p> <p>8-Digit Prefix .. Suffix # 096-2331 (-XXXX)</p> <p>1 PPM -0001 3 PPM -0003 5 PPM -0005 10 PPM -0010* 15 PPM -0015 20 PPM -0020 25 PPM -0025 30 PPM -0030</p>	<p>R.S. Sulfur Dioxide (SO₂) High Humidity Model 97</p> <p>8-Digit Prefix .. Suffix # 096-2337 (-XXXX)</p> <p>1 PPM -0001 3 PPM -0003 5 PPM -0005 10 PPM -0010* 15 PPM -0015 20 PPM -0020 25 PPM -0025 30 PPM -0030</p>

Miscellaneous		1/4 Turn Calibration Accessories	
<u>Part #</u>	<u>Description</u>	<u>Part #</u>	<u>Description</u>
096-2149	Separated sensor housing w/ 6 feet of cable, no junction box. For Duct Mount Adaptors	074-0305	¼ Turn (Teflon) Rain Shield
096-2118-6/8	6-8" Curved Duct Mount Adaptor	074-0344	¼ Turn Sensor Self Test End Cap Assembly
096-2118-F	Flat Duct Mount Adaptor	074-0345	¼ Turn Sensor Self Test End Cap Assembly (Rock Solid)
093-0097	Elastomeric Connector w/ O-Ring	096-2101	¼ Turn Calibration Plug Assembly (w/(1) ¼" NPT x 3/16" O.D. Barb Fitting)
096-2065	Heater Assembly ("P" models only)	096-2102	¼ Turn Flowcell Assembly (w/(2) 1/8" NPT x 3/16 O.D." Barb Fitting)
077-0127	Pump Assembly ("P" models only) Scott Health & Safety	096-2105	¼ Turn Sensor End Cap Assembly
077-0120	Scott Health & Safety Magnetic Screwdriver	096-2140	¼ Turn Hydride Sensor End Cap Assembly w/ IPA Filter (096-2103)
096-1943	Sensor Rain Shield/Calibration Adaptor (uses S.S. End Cap 073-0165)	096-2142	Condensing Humidity End Cap
096-1981	S.S. Sensor Housing-3/4" NPT (w/ window - does not include end cap)	096-2273	¼ Turn Sensor End Cap Assembly (Rock Solid)
096-2466	S.S. Sensor Housing-1-1/4" NPT w/ window (does not include endcap) - CSA Approved	096-2276	Condensing Humidity End Cap (Rock Solid)
096-2213	S.S. Sensor Housing-1-1/4" NPT w/o window (for condensing humidity applications)	096-2278	¼ Turn Calibration Plug Assembly (Rock Solid) w/(1) ¼" NPT x 3/16" O.D. Barb Fitting
073-0165	S.S. End Cap	096-2352	¼ Turn Methyl Mercaptan Sensor (4645) End Cap Assembly w/ Hydrogen Sulfide Getter Filter (096-2323)
073-0210	S.S. End Cap (Rock Solid)	096-2387	¼ Turn Phosgene Sensor (4650) End Cap Assembly w/ Hydrogen Cyanide Getter Filter (096-2386)
096-2249	Power Supply Board (MB) (w/o relays)		
096-2202	J-Box w/ Terminal Board only		
096-2203	J-Box P.C.B. Assembly		
096-2204	Spare J-Box Assembly (1-1/4" Fitting w/ 50 Ft. cable)		
096-2249-1	Power Supply Board (MB) (all relays normally open)		
096-2249-2	Power Supply Board (MB) (all relays normally closed)		
096-2249-3	Power Supply Board (MB) (alarm relays normally open/ fault relay normally closed)		
096-2249-4	Power Supply Board (MB) (alarm relays normally closed/ fault relay normally open)		
096-2248	CPU Board with Relays		
096-2151	Display Board		
096-2104	Dust Filter (H2S & CO only) (Bag of Qty. 10)		
096-2141	H2S Filter for HCN, NH3 & Hydride Sensors		
096-2146	(5) Condensing Humidity Membranes (for Humishield H2S only)		

Index

Symbols

- 20.0 mA Loop Cal Point 57
- 4-20 mA Fault Level 57
- 4-20 mA Inhibit Level 57
- 4-20 mA Scale Factor 57
- 4-20 mA Test Level 57
- 4.00 mA Loop Cal Point 57

A

- A1.OP 53
- A1.Rd 53
- A1.RP 53
- A1.Sd 53
- A1.SP 53
- A2.OP 53
- A2.Rd 53
- A2.RP 53
- A2.Sd 53
- A2.SP 53
- Accessibility, transmitter 7
- Addresses, Modbus[®] 67
- AF.NL 54
- AF.OP 54
- AL.IP 54
- AL.tO 54
- Alarm
 - acknowledging 25
 - indicators 1
 - latched 25
 - options 34
 - reset delay 35
 - reset point 35
 - set point 35
 - setup parameter changing 36
 - test operation 75-77
 - wiring 15
- Alarm Inhibit
 - automatic 34
 - period 34, 35
 - programming 34
- Alphanumeric Display 1
- ASCII characters 42
- Auto-Lock Time-Out, security 37

B

- Baud Rate. See Serial Communication.

C

- Calibration 26
- Circuit Breakers
 - UL/EN requirements 8
- COMM Menu 58
- Communication
 - connections 19
 - mode 60
 - options 61
- Conduit seals 7
- Contacting Scott Health & Safety 66
- Current Loop Connections 11-13
- Current Sinking Mode
 - defined 9
- Current Sourcing Mode
 - defined 9

D

- Damping constant. See Sensor Parameters.
- Data Access Register, Modbus[®] 67
- Data Length. See Serial Communication.
- Data Types, Modbus[®] 67
- Decimal Precision. See Sensor Parameters. See also Sensor Decimal Precision.
- Delays. See "Set" or "Reset" delay
- Delimiter string 58
- Digital Communications. See Serial Communications.
- Down key 24

E

- Electromagnetic fields 7
- Engineering units. See Sensor Concentration Units.
- Error Message Table 65

F

- F.CAL 62
- F.CS1 64
- F.CS2 64
- F.CS3 64
- F.dPG 63
- F.GCU 64
- F.HtC 62
- F.LbF 64
- F.LCd 64
- F.LSd 63
- F.LSt 63

F

F.MFG 64
F.MNt 63
F.PWd 62
F.RES 62
F.RNG 63
F.SCF 63
F.SGC 63
F.SMV 63
F.SP1 64
F.SP2 64
F.SSN 64
F.StC 63
F.tCF 63
F.tMR 62
F.tYP 63
F.ZMV 63
F.096 64
FACT Menu 62
Factory Defaults
 reset 62
 resetting 62
Fail-safe relay 34
Fault Code 65
FAULT Indicator 39
Fields, controlling the 51
Flowcell
 using 21
FSR register 71

G

Gas concentration units 1
Gas density 7
Gas interference 4
Gas number. See Sensor Gas Number.
Gas response 4
Gas sources 7

H

Hazardous conditions 35
HF Sensors 31

I

Inhibit 25
Installation, Transmitter. See Transmitter.
 Installation
Instrument Dimensions 10
Isolated Loop Power 9

J

Junction Box
 Mounting 8
 Electrical Installation 18

K

no entries

L

Latching relay 35
LCD
 display 24-25
LK.ON 56
LK.PW 56
LK.tM 56
Lock. See Security Indicator.
Lock Menu 56
Lock On/Off, security 37
Lock Password 37

M

MA.04 33, 57
MA.20 33, 57
MA.F 34, 57
MA.I 34, 57
MA.t 34, 57
MAINT indicator 39
Master Device, configuring 42
Maximum loop-voltage drop 8
Maximum Wire Length 8
Methyl Iodide Sensor 31
Minimum operating voltage 8
Minimum output voltage 8
Modbus®
 Address 67
 Data Access Register 67
 Data Access Register Descriptions 67
 data types 67
 drivers 67
 Function Descriptions 67
 protocol 44
 Register Table 75
 Using 44

N

Navigation, instrument 24
Non-Fail-safe relay 36
Non-Isolated Loop Power 9
Non-Latching relay 35

O

Orientation, transmitter 7
 Output
 inhibiting 25

P

Parity Checking 61

Q

no entries

R

Rain shield 5
 Real Time Clock
 (Date) 59
 (Hour) 59
 (Year) 59
 registers, Modbus[®] 67
 Report Delimiter String 58
 Report Fields 59
 Report Line Termination String 58
 Report On/Off 58
 Report Period 58
 Reset Delay 34
 RP.d1-RP.d5 58
 RP.E1-RP.E5 58
 RP.F1-RP.F8 59
 RP.ON 58
 RP.Pd 58
 RS-232 42
 Connections 19
 setting up 43
 wiring 16
 RS-485 42
 Connections 19
 setting up 43
 RS-485 selection 42
 RS-232 selection 42
 Rt.dt 59
 Rt.YR 59
 Rt.tM 59
 RUN Mode 24

S

SC.Ad 60
 SC.bR 60
 SC.dL 60
 SC.Id 60
 SC.LO 60
 SC.Md 60
 SC.OP 60

S

SC.P 61
 SC.RS 61
 SC.Rt 61
 SC.Sb 61
 SC.VF 61
 Security indicator 1
 Selecting gas type 5
 Sensor
 HF 31
 Methyl Iodide 31
 Sensor Parameters
 Concentration Units 64
 Damping Constant 55
 Decimal Precision 63
 Serial Number 64
 Temperature 63
 Temperature Units 55
 Type 63
 Sensor Self Test 39
 operation 39
 Serial Communication
 Address 60
 Baud Rate 60
 Data Length 60
 Idle 60
 Listen Only 60
 Mode 60
 Options 61
 Parity Checking 61
 Retries 61
 RS-232/485 Selection 61
 Stop Bits 61
 Verify 61
 Serial Communications 41
 setting up 42
 Set Delay 35. See *also* A1.Sd or A2.Sd.
 Software Version 64
 Span Calibration 29
 SR.dC 55
 SR.tC 55
 SR.tF 55
 St.ON 55
 St.dt 55
 St.t1 55
 St.t2 55
 St.Gt 55
 St.Rt 55
 Stop Bits 61
 SW.ID 64

T

- Tagging Data Elements, configuring 45
- Technical Specifications 66
- Temperature 7
- Temperature Units, sensor 55
- Termination characters 58
- Termination string 58
- Transmitter Installation 10
 - Accessibility 7
 - Ambient Temperature 7
 - bold sunlight 7
 - Conduit 7
 - electromagnetic fields 7
 - Gas Density 7
 - Gas Sources 7
 - Orientation 7
- Transmitter Security 36
- Transmitter Status Register 67
- Type gas. See Sensor Parameters.

U

- UL requirements, compliance 8
- UP key 24
- USER Menu 53

V

- Vapor Density. See Gas Density.
- Vibration 7

W

- Warranty 79
- Water 7
- Wire size 8
- Wiring 7

X

no entries

Y

- Year 2000 Compliance 79

Z

- Zero calibration 28
 - Frequency 26

